

RADIO'S LIVEST MAGAZINE

Special
Electronics
Number

Radio-Craft

April
25 Cents
in United States
and Canada

HUGO GERNSBACH, Editor

THE ELECTRON MAGAZINE
Subscription 594

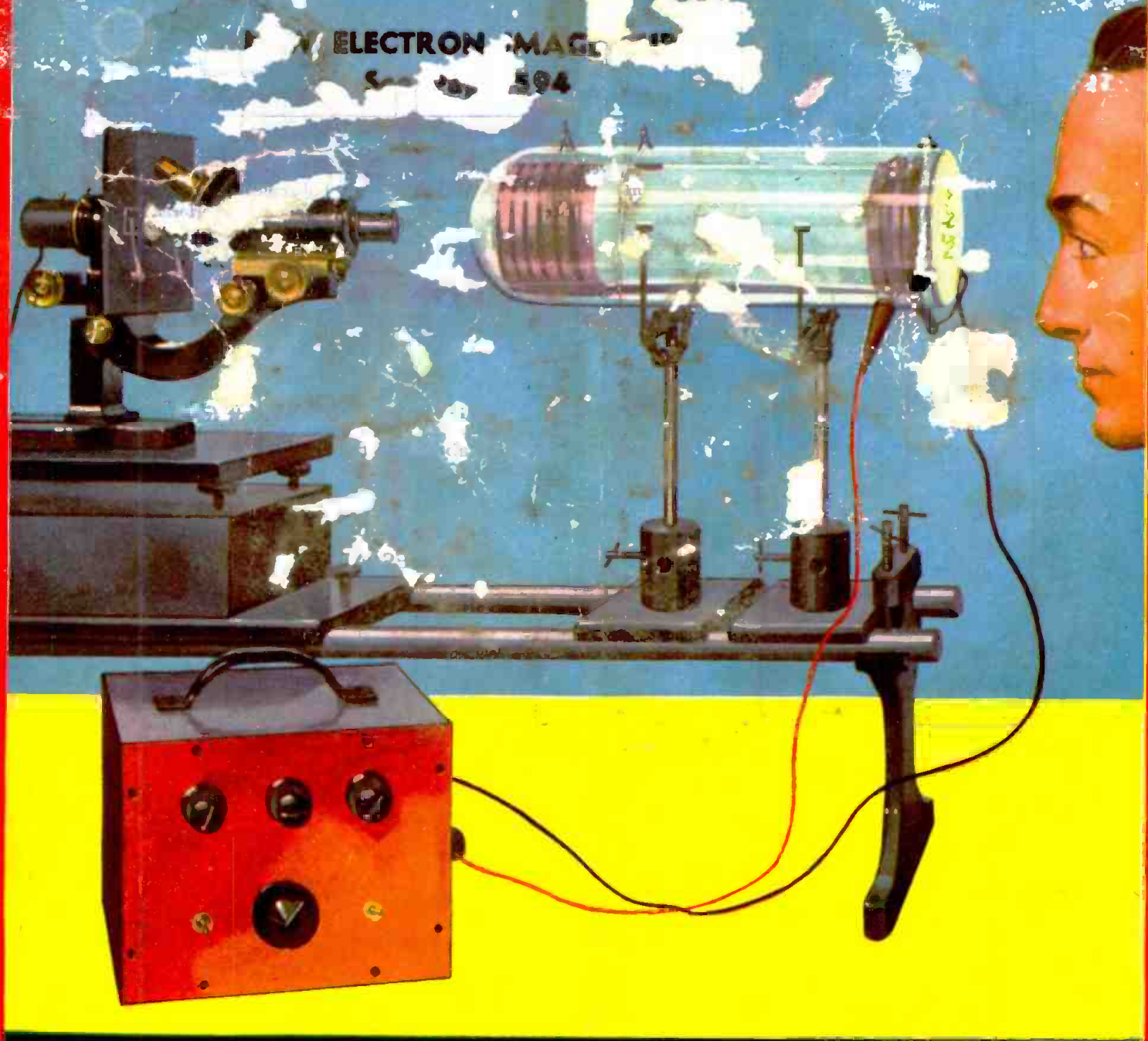

Musical Static!—Resistance-Capacity Tester—Electronic Music Fundamentals
Beginner's 2-Tube Set—Direct-Impedance Amplifier—Radio Set for the Blind

Before It's Too Late



Equip Now with New
LABORATORY MODEL
SUPREME
INSTRUMENTS
thru an
F.H.A. LOAN

12 Small Monthly Payments
Buy Any One Instrument

18 Small Monthly Payments
Buy Any Two or More Instruments



SUPREME 385 AUTO-
MATIC LABORATORY
MODEL **\$77⁹⁵**



SUPREME 89 DeLUXE
TUBE TESTER LABO-
RATORY MODEL **\$45⁹⁵**



SUPREME 189 SIGNAL
GENERATOR LABO-
RATORY MODEL **\$36⁹⁵**



SUPREME 339 DeLUXE
ANALYZER LABORA-
TORY MODEL **\$39⁹⁵**

Radiomen by the thousands are grasping this opportunity to modernize their equipment with the financial help of Uncle Sam. Supreme Jobbers are overwhelmed with orders! Banks welcoming the business! It's YOUR big chance, Mr. Serviceman, to enjoy the prestige and profit of radio's most up-to-the-minute testing instruments on the easiest possible purchase plan.

**FHA MAY NOT BE EXTENDED!
EXPIRES APRIL 1st!**

Up to now there has been no definite report from Washington that the FHA Act will be extended at expiration April 1st. Don't gamble with chance—see your jobber NOW while you know Uncle Sam will assist you to pay for one instrument over a period of 12 months, and 2 or more, 18 months—at the government's low interest rate. Write Supreme direct for any information with which your jobber can not supply you.

Supreme Instruments Corp., Greenwood, Miss., U.S.A.

• Export Dept., Associated Exporters Co., 145 West 45th St., New York City, N. Y. Cable Address, LOPREH, N. Y. •

STOP WISHING

FOR A GOOD-PAY JOB...

TRAIN FOR ELECTRICITY AND GET ONE!

MANY MAKE \$30, \$40, \$50, AND UP EVERY WEEK IN ELECTRICITY

It makes no difference whether your age is 16 or 40. . . . If you want to feel secure and not have to worry about being laid off or to have to work for any wages they want to pay you—prepare today for real opportunities in the liveliest money making field in the world. Electricity offers you the opportunity to make REAL MONEY! If you want to enjoy the good things in life that real money will make possible . . . the surest and quickest way is to get into a field that offers REAL MONEY-MAKING OPPORTUNITIES. The great and growing field of Electricity—with its vast developments reaching into almost every industry—needs men with PRACTICAL TRAINING. It pays well, and offers a future that is practically unlimited.

LEARN BY DOING IN 12 WEEKS

My great training shops in Chicago are known the world over for the amazingly easy, practical method by which we train ambitious fellows for good pay Electrical jobs in only 12 weeks. Start any time. You learn quickly by doing actual shop work on real Electrical machinery—without book study or useless theory. Previous Electrical experience or a lot of book learning not necessary. Expert instructors personally guide you every step of the way.

I'LL FINANCE YOUR TRAINING!

Don't let lack of ready cash hold you back. My plan has enabled thousands of deserving fellows to get Coyne Training first—then pay back tuition in small monthly payments extended over 18 months after graduation starting 5 months after you start school or 2 months after your required training period. Many have told me that their training has more than paid for itself out of increased earnings! Prove to me that you really want to succeed—by mailing the coupon below—and I'll tell you about this amazingly liberal plan.

H. C. Lewis



Free Lifetime Employment Service

A Free Employment Service is maintained to give Coyne graduates every possible aid in locating jobs for which they are trained. Many of our students do part-time work to help pay their living expenses while in school.

Diesel Engines Refrigeration and Air Conditioning
 Trained men are needed in these rapidly expanding branches of the great Electrical field. Right now I'm including instruction in Diesel Engines, Electric Refrigeration and Air Conditioning AT NO EXTRA COST.

Get the Facts Send for Free Book

The whole fascinating story of Coyne Training is yours for the asking. Just mail the coupon and I'll send you my Big Free Book, with photographs, jobs, and money-making facts. There's no obligation and no salesman will call.

COYNE H. C. LEWIS, President **FOUNDED 1899**
ELECTRICAL SCHOOL
 500 S. Paulina Street, Dept. 46-78, Chicago, Ill.

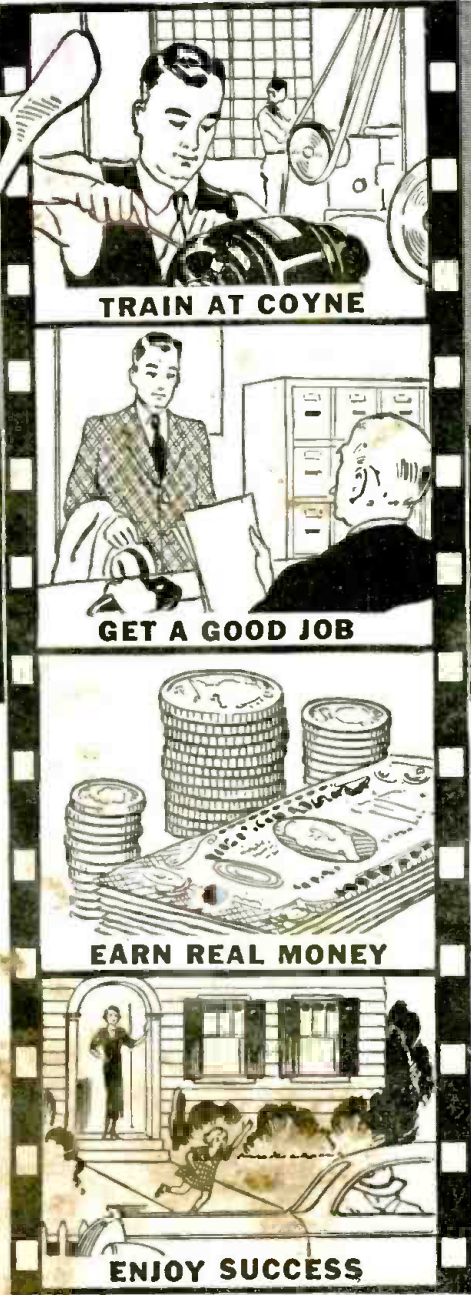

HERE'S PROOF... that Coyne Training gets Quick Results!

"Two weeks after leaving school I took a wiring job, and the profits from this job alone more than paid for the entire course."

—E. O. BERNDT, ILLINOIS

"Coyne Training has certainly paid for itself many times in increased salary."

—PAUL W. HOLDTON, OHIO

"I owe my Electrical success to your 12-week shop course."

—R. B. UMBARGER, TENN.

"Coyne Training got me this job which has a wonderful future."

—SHERMAN PENNY, FLORIDA

These and thousands of similar letters in our files give positive proof of the REAL MONEY VALUE of Coyne Training. These men once faced the same problem that now confronts you. Coyne Training started them on the road to success...it can do the same for you.

MAIL the COUPON for FREE BOOK!

H. C. LEWIS, Pres., COYNE ELECTRICAL SCHOOL
 500 S. Paulina St., Dept. 46-78, Chicago, Ill.

Without obligating me, send Free Book and details of your "Pay-Tuition-After-Graduation" Plan.

Name.....
 Address.....
 City..... State.....

Mail in envelope or paste on a postcard.



CONTENTS—APRIL 1936, ISSUE

Volume VII

Number 10

Editorial: Radio-Electronics.....	Hugo Gernsback	581
The Radio Month in Review.....		582
Musical Static!—Introducing RADIO-CRAFT'S "Rubber-band Amplification".....		584
Making a "Personal Set" for the Blind.....	C. W. Palmer	585
Newest Applications of Electronics.....		586
How to Make a "Magic Eye" Output Indicator.....	Charles Sicuranza	587
The Singing Keyboard.....	Frederick M. Sammis	588
Opening Doors Automatically.....	Harry F. Dart	589
An A.C.-D.C. Electronic Relay.....		589
Radio Pictorial.....		590
Electronic Music Fundamentals Part I.....	Edward Kassel	592
Making a Compact Resistance-Capacity Tester.....	Allen Beers	593
Tapers of Modern Variable Resistors.....		593
The Electron Image Tube.....		594
New Developments in P.A. Amplifiers.....		595
Equipment for the Service Man.....	A. A. Ghirardi	595
Operating Notes.....		596
The Design of Modern Test Equipment Part I.....	Samuel C. Milbourne	597
Metal Tube "Short" and "Open" Tester.....	G. F. Benkelman	597
Automatic Electronic Potentiometer.....		598

HUGO GERNSBACK, Editor-in-Chief
 C. W. PALMER Associate Editor
 H. G. McENTEE Associate Editor
 R. D. WASHBURNE, Technical Editor

Distortion in Resistance-Coupled Amplifiers.....		598
The Versatility of the Oscilloscope.....	R. D. Washburne	599
Modernizing the Set Analyzer.....	R. P. Hiltner	600
Requirements in Servicing 16 mm. Talkies.....	J. J. Bressler	600
Short Cuts in Radio.....		601
The Latest Radio Equipment.....		602
Cornerstones of Radio—The Bridge Part II.....	E. W. Slope	604
How to Make a Beginner's 2-Tube Portable.....	J. T. Bernsley	605
New Radio and Industrial Tubes.....	J. H. Green	606
An Easily-Made Stroboscope.....		607
Uses of Low-Voltage Thermionic Rectifiers.....	Russell E. Mahning	607

RADIO-SERVICE DATA SHEETS:

No. 160—Philco Model 59, 4-Tube A.C. Midget Receiver; Ford Philco Radio Model FT9 6-Tube Auto Receiver.....		608
No. 161—Zenith Farm Model 6V 27, 6-Tube Superheterodyne Receiver.....		610
No. 162—Ward's 10-Tube All-Wave High-Fidelity Superhet. Series ODM.....		611
Direct-Impedance Amplification Part I—A 10-Tube Set.....	L. Mitchell Barcus	609
ORSMA Members' Forum.....		612
Technicians' Data Service.....		614

(ANNUAL) P. A. NUMBER

Just as, last year, we favored the public-address specialist, in regard to the nature of much of the technical material presented in the May issue of RADIO-CRAFT, so, too, we have once more planned to give the P.A. technician valuable reference information with respect to this important field, in the forthcoming May issue.

At the same time, there will be numerous articles, both constructional and theoretical, that the Service Man, engineer, experimenter and beginner will find invaluable. To list only a small proportion of the forthcoming contents would afford but slight insight as to the importance and variety of this issue.

Therefore, we can only urge you to reserve your newsstand copy (release date April 1) of the May issue, today.

HUGO GERNSBACK, President I. S. MANHEIMER, Secretary
 Published by Continental Publications, Inc. Publication office: 404 N. Wesley Ave., Mount Morris, Illinois. Editorial and Advertising Office: 99 Hudson Street, New York City. Chicago Advertising Office: L. F. McClure, 919 North Michigan Avenue, Chicago, Ill. Western Advertising Office: Loyd B. Chappell, 511 So. Alexandria St., Los Angeles, Calif.

European Agents:

London—Gorrings's American News Agency, 9A Green St., Leicester Square, London, W. C. 2.

Paris—Messageries Dawson, 4 Rue Faubourg, Poissonniere, Paris, France.

Australian Agent: McGill's Agency, 179 Elizabeth St., Melbourne.

RADIO-CRAFT is published monthly, on the first of the month preceding that of date; its subscription price is \$2.50 per year. (In Canada and foreign countries, \$3.00 a year to cover additional postage.) Entered at the post office at Mount Morris, Ill., as second-class matter under the act of March 3, 1879.

Text and illustrations of this magazine are copyright and must not be reproduced without permission of the copyright owners. We are also agents for WONDER STORIES and EVERYDAY SCIENCE AND MECHANICS. Subscription to these magazines may be taken in combination with RADIO-CRAFT at reduced Club rates. Write for information.

Copyright 1936. Continental Publications, Inc.



J. E. Smith
President
National Radio
Institute

I WILL HELP YOU START A SPARE TIME OR FULL TIME RADIO SERVICE BUSINESS WITHOUT CAPITAL

**Free Book Tells How.
Mail Coupon!**

One million dollars is being spent on two stations. Receiving sets are being designed and built. New opportunities—many of them—are right ahead. My book tells you of the opportunities in these fields, also in Aviation Radio, Police Radio, Short Wave Radio, Automobile Radio and other new branches of this fast growing industry. Get it.

**HERE ARE A FEW EXAMPLES
OF THE KIND OF MONEY
I TRAIN MY MEN TO MAKE**

Now Has Fine Business

"I have a fine business servicing sets. I am making a good living—seldom have a week under \$40.—It wasn't for N. R. I., I would probably be tramping the streets.

Glenn C. King,
46 Division Ave., S.,
Grand Rapids, Mich.



\$15 a Week in Spare Time

"My spare-time earnings average \$15 a week. Since studying with you I have earned about \$8,000 in Radio. I owe my success to the good method of the N. R. I."

C. N. Heffelfinger,
R. F. D. No. 1,
Temple, Penna.



Best Equipped Shop in Town

"In the last year, we have moved our Radio shop and we now have the best equipped Radio Repair Shop in East Toledo. We also have a shop at 624 Milton Street. We have three fellows working for us."

W. R. Brown,
309 Main St.,
Toledo, Ohio.



The world-wide use of Radio sets for home entertainment has made many opportunities for you to have a spare time or full time Radio service business of your own. The day you enroll I start sending you Extra Money Job Sheets which quickly show you how to do Radio repair jobs common in most every neighborhood. Many N. R. I. men make \$5, \$10, \$15 a week extra in spare time while learning. I show you how to install service all types of receiving sets. I give you Radio equipment and instructions for conducting experiments for building circuits and testing equipment, and for making tests that will give you broad, practical Radio experience. Clip the coupon below and get my free 64-page book, "Rich Rewards in Radio." It gives you a full story of the success of N. R. I. students and graduates, and tells how to start a spare time or full time Radio service business on money made in spare time while learning.

**Many N. R. I. Men Make
\$5, \$10, \$15 a Week Extra
in Spare Time While Learning**

Many of the twenty million sets now in use are less than 50% efficient. I will show you how to cash in on this condition. I will show you the plan and idea that have enabled many others to make \$5, \$10, \$15 a week in spare time while learning. George W. Honert, 248 Water St., Ligonier, Ind., made over \$500 from the start of the Course to its completion.

**Get Ready Now for a Radio
Business of Your Own and
for Jobs Like These**

Broadcasting stations use engineers, operators, station managers, and pay up to \$5,000 a year. Radio manufacturers use testers, inspectors, foremen, engineers, servicemen and buyers, and pay up to \$6,000 a year. Radio dealers and jobbers employ hundreds of servicemen, salesmen, managers, and pay up to \$75 a week. Television promises many good jobs soon. Television is leaving the laboratory in an impressive way.

**I Train You at Home
in Your Spare Time**

Hold your job until you're ready for another. Give me only part of your spare time. You do not need a high school or college education. Hundreds with only a common school education have won bigger pay through N. R. I. Graduate J. A. Vaughn jumped from \$35 to \$100 a week. Fred Dubuque doubled his earnings in one year. The National Radio Institute is the Pioneer and World's Largest organization devoted exclusively to training men by Home Study for good jobs in the Radio industry.

You Must Be Satisfied

I will give you an agreement to refund every penny of your money if you are not satisfied with my Lesson and Instruction Service when you complete my Training. And I'll not only give you thorough training in Radio principles, practical experience in building and servicing sets, but also Advanced Specialized Training in the type of Radio work you choose.

Get My Free Book of Facts

Mail the coupon for "Rich Rewards in Radio." It's free to any ambitious fellow over 15 years old. It tells you about Radio's spare time and full time opportunities; about my training; what others who have taken it are doing and making. Mail coupon now in an envelope, or paste it on a 1c post card.

J. E. SMITH, Pres.
Dept. 6DX
**National Radio
Institute**
Washington, D. C.



**You Get PRACTICAL EXPERIENCE
with Radio Equipment I Give You**

I'll show you how to use my special Radio equipment for conducting experiments and building circuits which illustrate important principles used in such well known sets as Westinghouse, General Electric, Philco, R.C.A., Victor, Atwater-Kent, and others. You work out with your own hands many of the things you read in our lesson books. This 50-50 method of training makes learning at home easy, interesting, fascinating, intensely practical. You learn how sets work, why they work, how to make them work.



**Get my FREE LESSON
on Radio Servicing Tips**

I'll prove that my Training gives practical, money-making information, that it is easy to understand, that it is just what you need to master Radio. My sample lesson text, "Radio Receiver Troubles—the Cause and Remedy" covers a long list of Radio receiver troubles in A.C., D.C., battery, microphone, auto, T.R.F., super-heterodyne, all-wave, and other types of sets. And a cross-reference system gives you the probable cause and a quick way to locate and remedy these set troubles. A special section is devoted to receiver check-up, alignment, balancing, neutralizing and testing. Get this lesson Free. No obligation. Just mail coupon.

MAIL COUPON NOW

**This Coupon is Good for One
FREE COPY OF MY NEW BOOK**

J. E. SMITH, President,
National Radio Institute,
Dept. 6DX,
Washington, D. C.

Dear Mr. Smith: Without obligation, send me the Sample Lesson and your free book about spare time and full time Radio opportunities, and how I can train for them at home in spare time. (Please print plainly.)

Name..... Age.....

Address.....

City..... State..... 14x1

Find out about the World Famous Course that Pays for Itself

Special Announcement

To-date we have issued the following publications of vital importance to service men:

1931 Official Radio Service Manual

1932 Official Radio Service Manual

1933 Official Radio Service Manual

1934 Official Radio Service Manual

1935 Official Radio Service Manual

Official Auto-Radio Service Manual (Vol. No. 1)

Official Auto-Radio Service Manual (Vol. No. 2)

Every Service Man, in order to be properly equipped to service the older sets, which naturally cause the most trouble, should have the complete set of these manuals. With this end in view we are desirous of making a special proposition to anyone who has some of these manuals but not the complete set.

If you will be good enough to fill in the coupon appearing below, and mail it to us, we will make you a proposition to enable you to fill in the missing manuals and pay for them on an installment proposition.

**MAIL
COUPON
TODAY!**

Gernsback
PUBLICATIONS,
INCORPORATED

99 HUDSON ST. NEW YORK, N.Y.

Gernsback Publications, Inc. RC-436
99 Hudson St., New York, N. Y.

I now own the following manuals (check the one you now have).

- 1931 Official Radio Service Manual
- 1932 Official Radio Service Manual
- 1933 Official Radio Service Manual
- 1934 Official Radio Service Manual
- 1935 Official Radio Service Manual
- Official Auto-Radio Service Manual (Vol. No. 1)
- Official Auto-Radio Service Manual (Vol. No. 2)

Will you kindly mail me a special proposition whereby I may secure the missing ones. It is distinctly understood that the sending of this coupon does not obligate me in anyway.

Name

Address

City State

I'LL TRAIN YOU *Quickly* FOR SPARE-TIME AND FULL-TIME JOBS IN ELECTRICITY



BY PRACTICAL SHOP METHODS
in your spare time
RIGHT IN YOUR OWN HOME

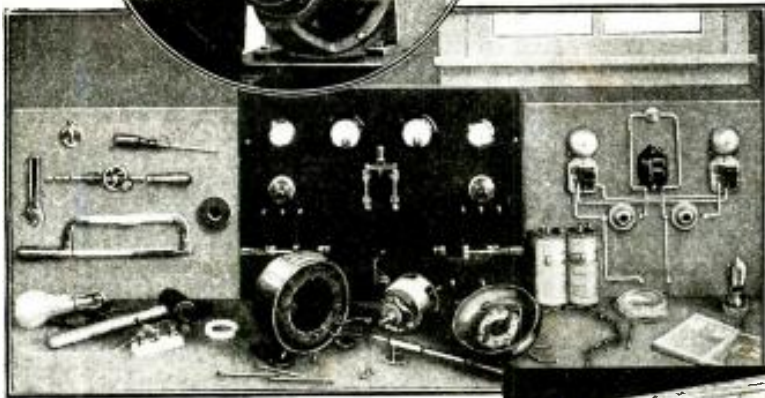

Learn to earn up to \$50 a week or more in a real money-making field. Electricity today offers opportunities undreamed-of a few years ago... steady jobs... interesting work... good pay... a real future. And now Electric Institute brings **to your very door** — the practical training necessary to qualify for the rich rewards that are waiting. There is no need to give up your present job... no need to leave home, family and friends... no need to travel hundreds, perhaps thousands, of miles to some distant city; pay out large sums of money for traveling and living expenses. Now, you can learn Electricity by a simple, easy, practical method... right at home... at a fraction of the cost of going away to school... and with full assurance of your money back if you're not entirely satisfied.

LEARN BY DOING ACTUAL JOBS IN YOUR OWN ELECTRICAL WORK SHOP... WE FURNISH EQUIPMENT

Electricity is a practical subject which must be taught in a practical way. That's why we furnish each of our students with dozens of items of real electrical equipment and apparatus in addition to his course of study... so you can do the actual work on real electrical jobs... make tests... perform your own experiments. This equipment is furnished **without extra cost**, not only to aid your training, but to be used to go out and do real jobs... real installations and repairs that you can get real money for. In fact, by doing only two or three such jobs a month your training should actually pay for itself... and the opportunities for extra spare-time earnings are simply amazing!

YOU DON'T NEED PREVIOUS EXPERIENCE OR A LOT OF BOOK LEARNING TO PREPARE FOR JOBS LIKE THESE:

New electrical projects, constantly increasing use of electric power, means more jobs for men with practical training. There is scarcely a large industry today that does not use trained electrical men in some part of their work. Maintenance work, lighting and illumination, automotive electricity, manufacturing, service and repairs, power plant work, switch-board operation, sub-station operation... all offer real opportunities to trained men who can qualify. Or, if you prefer to own and operate an electrical business of your own, Electric Institute training and the equipment furnished will give you a start.



H. W. PETERSON
President, Electric Institute



THIS FREE BOOK TELLS YOU HOW

DIESEL, ELECTRIC POWER, RADIO and REFRIGERATION

Complete course includes practical training in Diesel Electric Power, Radio, Electric Refrigeration and Air Conditioning. **START NOW** and prepare to take advantage of the opportunities that are waiting for trained men in these fields and in many other branches of Electricity. It's easy to get all the facts about Electric Institute Training... it takes only a postage stamp to mail the coupon... and that little coupon may be the turning point in your life, if you'll give it a chance.

—EARN EXTRA MONEY BY DOING PART TIME JOBS WHILE LEARNING!

Opportunities to make \$5, \$10, or more a week while training.

By the most practical, most amazingly easy method of home shop training, the fascinating mystery of electricity is unfolded to you step by step in a way that anyone can quickly understand and which is intended to make you a real practical trained man and not a theoretical engineer. I have designed this course so that it is possible for my students to start earning money almost at once. Do not confuse Electric Institute Training with a theoretical course, with dry text books and tiresome theories. By this new method, you are told—in plain, simple words—exactly what to do, and why... then you do the actual jobs, with real, full-size electrical equipment which we furnish without extra cost as a regular part of your training. That's the modern, easy Electric Institute way... become a practical skilled electrician in your spare time without leaving your present job until you are ready to step into a real electrical job.

GET INTO A GROWING FIELD FOR BIG PAY AND A FUTURE

There is no better way to succeed in life than to train for specialized work in an industry that is expanding. Such opportunities are waiting in the great and growing field of Electricity, where trained men are always needed. And Electric Institute is ready to show you the way. Mail the coupon now—**TODAY**—for Big, New, Free Book and all facts about this revolutionary plan of home shop training. There is no obligation, and no salesman will call on you. The book costs nothing... but it may be worth a fortune to YOU!

RUSH THE COUPON... TODAY!

H. W. Peterson, President
ELECTRIC INSTITUTE, INC.,
5840 Addison St., Dept. 156D, Chicago, Ill.
Send Free Book with all facts about E. I. Home Shop Training.

Name..... Age.....

Address.....

City..... State.....

ELECTRIC INSTITUTE, Inc. H.W. PETERSON
PRESIDENT

5840 ADDISON STREET, Dept. 156D, CHICAGO, ILLINOIS

Please Say That You Saw It in RADIO-CRAFT

Announcing a New Book for Radio Men!

Official Radio Service Handibook

by J. T. Bernsley

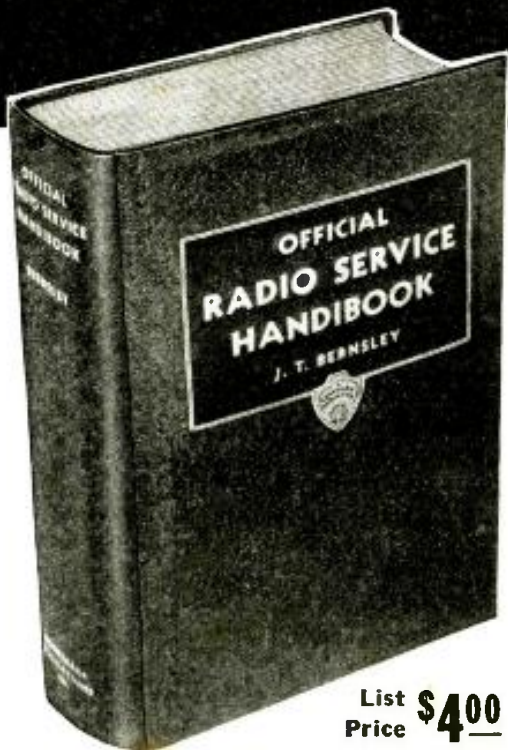

List Price **\$4.00**

**OVER
1,000
PAGES**

Over 750 Illustrations

6X9 inches

Beautiful Leatheroid Cover

**OVER 250 PAGES
OF OPERATING NOTES**

Whether it is a fading job, lack of sensitivity, noise within the receiver, alienating a chassis, poor A.V.C. action or any other trouble that is usually the "bugaboo" of most Service Men you will find the symptoms and remedy clearly described in **OFFICIAL RADIO SERVICE HANDBOOK**. The exact procedure for repairing, as well as the characteristic trouble in almost all models of manufactured sets, will be found in the section on **OPERATING NOTES**—over 250 pages of this data, the most pertinent information to any radio man in the servicing field. The material in this section has been arranged, as well as classified, so there is no difficulty in immediately locating the necessary information.

HERE'S the sensational new book on radio servicing that contains everything Service Men must know. The book, **OFFICIAL RADIO SERVICE HANDBOOK**, is edited by J. T. Bernsley, foremost radio service authority. This 1936 service guide is the *only book of its kind*—its editorial material is so well prepared that the technical information can be understood by even beginners in radio servicing. Every page contains new material, new illustrations—no reprinted literature or rehashed articles.

Over a thousand actively engaged Service Men have helped prepare the service data found in the **OFFICIAL RADIO SERVICE HANDBOOK**. Their contributions, in the form of service notes, short cuts, and trade secrets make this book the outstanding volume on radio servicing ever to be published.

The **OFFICIAL RADIO SERVICE HANDBOOK** covers thoroughly over 500 radio topics. It tells you how to analyze the latest commercial receiver circuits; how to really make money servicing midget sets; and, how aligning supers can be made easy. It stresses the many uses of different types of test equipment; it gives you short cuts in trouble-shooting and repairing; and, contains over 250 pages of operating notes on 1,000 manufactured receivers. So up-to-date is the **OFFICIAL RADIO SERVICE HANDBOOK** that it explains thoroughly what to do when a receiver with the "Magic Eye" goes "cockeyed."

Service Men, previously advised about this great book on servicing, have already ordered their copy. Order your copy NOW if you have not already done so.

SENSATIONAL PRIZE CONTEST!

\$1,800 Worth of Prizes to Be Awarded to Service Men

You should be interested in entering one of the greatest radio contests of all times. There are 147 prizes in valuable servicing equipment and radio accessories, totaling over \$1,800, to be distributed. All the details about entering this contest, including a complete list of the 147 prizes, will be sent upon request—simply mail the coupon below.

Partial Contents of this Great Book

PART 1—CIRCUIT THEORY AND ANALYSIS

R.F. Fundamentals; Superheterodyne Receiver Theory; A.V.C. and Tuning Indicator Circuits; A.F. Fundamentals; Power Supply Theory and Circuits; Speakers, Reproducers and Pick-Ups; Commercial Receiver Circuits of All Types, How to Analyze.

PART 2—MODERN SERVICING AND TEST EQUIPMENT

Fundamentals of Metering and Test Equipment; Standard Servicing Instruments; The Cathode Ray Oscilloscope and Associate Instruments; How to Build Essential Servicing Test Instruments.

PART 3—PRACTICAL SHORT-CUTS IN TROUBLE SHOOTING AND REPAIRING

Localizing Trouble by Inspection Methods; Short-Cuts with Test Instruments; How to Quickly and Properly Perform All Types of Repairs; Unusual Servicing Experiences; Tube Troubles and Characteristics.

PART 4—SPECIALIZED RECEIVER AND INSTALLATION DATA

All-Wave and High Fidelity Receiver Servicing and Installation Data; Auto Radio Receiver and Installation; Specialized Servicing and Installation (Remote Tuning Controls, Home Recording, Automatic Record Changers, Apartment House Antennas, etc., etc.); Eliminating Noise Interference.

PART 5—MODERNIZATION AND CONVERSION DATA

Modernizing and Improving Methods for All Types of Receivers; Converting A.C. Receivers for D.C. Operation and Vice Versa.

PART 6—SOCIAL AND ECONOMIC PROBLEMS OF THE SERVICE MAN

Improving Knowledge and Technique; Social Problems—How to Organize. Listing of Servicemen's Organizations; The Future of the Servicing Profession.

PART 7—OPERATING NOTES AND PRACTICAL DATA LISTINGS

Operating Notes on Over 1,000 Receivers; I.F. Peaks of Approximately 3,000 Receivers; Voltage Dividers for 300 Receivers; Speaker Field Listing; Radio Mathematics and Measurements.

**CLIP
COUPON
MAIL
TODAY!**

GERNSBACK PUBLICATIONS, Inc.
99 Hudson St., New York, N.Y.

Gentlemen: Enclosed you will find my remittance of \$1.00 for one copy of the **OFFICIAL RADIO SERVICE HANDBOOK**. YOU ARE TO SEND THIS BOOK TO ME POSTAGE PREPAID.

SEND ME IMMEDIATELY THE CONTEST BLANK FOR ENTRY IN THE \$1,800 PRIZE CONTEST.

Name _____

Address _____

City _____ State _____

(We accept cash, stamps, money orders or U.S. checks in connection with this offer. If you send cash, be sure to register your letter.)

GERNSBACK PUBLICATIONS, INC.

99 Hudson Street

New York, N. Y.

Please Say That You Saw It in RADIO-CRAFT



"Takes the Resistance out of Radio"

Editorial Offices: 99 Hudson St., New York, N.Y.

HUGO GERNSBACK, Editor

Vol. VII, No. 10, April, 1936

RADIO-ELECTRONICS

An Editorial by HUGO GERNSBACK

WHEN the radio or electrical engineer talks of *electronics* these days, he usually links radio and electronics together, because in practically all cases, the two arts work hand in hand. As a matter of fact, it is often difficult to even dissociate the two arts because neither would be practical without the other.

Radio, which today is founded upon the vacuum tube—an electronic device—could not very well get along without electronics.

Electronics, on the other hand, in the majority of cases, could not get along without its radio amplifiers and its many other radio devices. It is true that there are a number of electronic devices which do not make use of radio technique, but these may be called exceptional.

Such devices as selenium cells, and a number of self-operating photoelectric cells, such as those which operate electric meters, and which transform light into electricity directly, are examples of such devices.

Generally speaking, however, electronics today relies largely upon radio instrumentalities, and in all probability will continue to do so at an ever increasing rate.

It is astonishing, the many new uses to which electron tubes can be put, and new ideas are being evolved so rapidly that it is sometimes difficult to keep track of them. Industry uses electronic devices in the most unexpected places, and there is hardly a factory today which does not make use of some new electronic device for some new purpose.

The radio vacuum tube and the photoelectric cell are, of course, only a few of the electronic generators used in the electronic art. New and astonishing electron tubes are being perfected almost weekly.

It may be stated that electron tubes were first proposed by the English scientist Crookes, who himself invented many curious electronic tubes, which, actuated by high-frequency currents, gave us our first good insight into the behavior of electrons in rarified gases. The well-known and colorful Geissler tubes of our boyhood days—those tubes which light up so brilliantly under the influence of a spark coil or static machine—were also based on Crookes' work.

One of the most prolific designers of vacuum tubes, however, is, no doubt, Nikola Tesla, one of the most illustrious scientists of our age. Although it is not well known, Nikola Tesla actually designed hundreds of different electronic tubes, all of which performed different functions in connection with his memorable researches in the field of high-frequency currents.

Tesla was the first man to demonstrate that such tubes could be lit brilliantly with a single connection attached to his high-frequency generator and that a return wire was not required.

Indeed, Tesla many years ago demonstrated his "wireless light," whereby some of his curious electron tubes could be lit over a considerable distance without any wires at all.

This brings us to one of the great and coming uses of the electronic art of the future. It has long been the dream of scientists and radio engineers to send *power* by radio at a distance. So far this has only been a dream, because while power could be sent over relatively small distances, the efficiency of the device usually was infinitesimal (as for instance in sending and receiving radio programs). In the future, however, the chances are that electronic devices

will have been perfected to such an extent that it will have become possible to send powerful streams of electrons not only through a vacuum as we are doing today, but through the air.

Tesla still maintains that in the future we will have power stations which will disseminate power without any intervening wires. That such power will be projected by electronic means seems a foregone conclusion. We are still in ignorance as to just how it will be accomplished. The future, however, will tell.

One of the great problems to be solved by the radio engineer in the near future will no doubt be the elimination not only of *man-made* static but *natural* static. As I pointed out in the June, 1934, issue of *Radio-Craft*, it is my opinion that if static ever is to be conquered, it will be by means of an electronic device, and probably by means of a vacuum tube.

That this prediction rests upon a solid foundation is best shown by the recent experiments of Major Armstrong, who by means of radio circuits and vacuum tubes exactly demonstrated this idea, and, as we go to press, additional confirmation of this idea comes from the experimental laboratories of the American Radio Relay League.

According to the A.R.R.L. report, use is made of a "check valve." The general principle comprises a radio tube paralleling another tube in the receiver's intermediate frequency amplifier stage followed by a rectifier. This in connection with a so-called "balancer circuit" practically eliminates man-made static, natural static, though, as yet remains unconquered.

It is no question, however, but that we are now on the threshold of actual static elimination via the electronic tube. Such an invention will, no doubt, revolutionize the entire art of radio and make it possible to do things which engineers have been dreaming about for years. Lack of space prohibits mention of all the applications of "static-less radio," but the following is probably one of the most important uses.

At the present time, when we speak of a "broadcast radio hookup" we think of a number of stations which are connected together by means of telephone wire-lines.

When the president broadcasts a message from Washington his message is seldom received, by the radio listener, directly from Washington—except in the case of a Washington broadcast station putting his speech on the air.

Instead, a Chicago or San Francisco station is connected by an actual wire line with Washington, D.C., then in Chicago or San Francisco the message goes out by radio from the respective local station.

Up to now it has not been possible to connect radio stations together and form a hookup solely by radio (that is, without recourse to the wire tie-in lines) due to the static interference. However, once the static eliminator has been perfected it will then be possible to do away with telephone and wire lines, and have a complete broadcast hookup entirely by radio; in which event it is probable that the stations will be hooked together by *short waves*.

"I am certain that there are some electrical means whereby the unwanted noises can be tuned out or filtered out, or a combination of both may be adapted. I personally believe that it is not a question of aerials at all, and that the final solution will be in the set itself! It probably will be accomplished by the means of a vacuum tube, or a similar instrumentality." (June, 1934, issue of *Radio-Craft*.)

THE RADIO MONTH

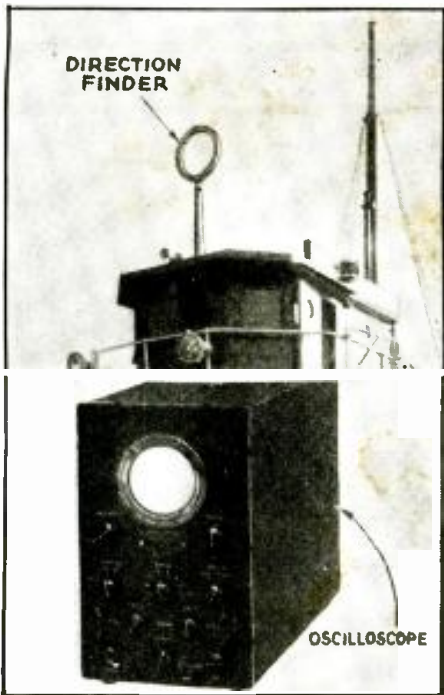

Two radio devices used to track-down the "shadow"—the direction finder and the oscilloscope.

RADIO "SHADOW" UNMASKED AT LAST

LAST month the answer was found to a question which for some time has stumped radio operators, short-wave listeners and the entire radio profession.

As some readers may know, a mysterious type of radio interference in the form of a low-pitched hum similar to a 60-cycle line hum has been interrupting radio communication on certain short wavelengths, especially between the frequencies of 11,000 and 20,000 kilocycles. The hum has been heard irregularly and it apparently changed in frequency from time to time.

This mysterious "shadow" as it has been affectionately (or not so affectionately) called, has puzzled some of the best-known engineers in the radio industry and become so important during the past 6 months that RCA Communications, Inc., spent many hours making "fingerprints" of its tone, wavelength, waveform, and direction of emanation.

Finally, the "shadow" was unmasked, last month (after many possible sources were tracked down) by the U.S. Navy!

The mysterious hum which was reported from all parts of the U.S., Honolulu, Nova Scotia, Puerto Rico and the Canal Zone has been traced to the high-frequency vacuum tubes used by hospitals and doctors in certain medical treatments. The findings were turned over to the F.C.C. for further consideration. It is stated that proper shielding will eliminate the "shadow."

PHOTO-CELLS GIVE TELEPHONE TIME SERVICE

THE Post Office Department in Berlin, Germany, made known last month that it is testing a new apparatus which automatically announces the time to all telephone subscribers. The device consists of a drum on which narrow tone-film strips are placed so that they cover one-half of the drum. Twenty-four tonebands are recorded, one for each hour of the day, and 6 strips are recorded for the minutes. The tonebands are scanned by 2 photoelectric cells (one for the *hours*, and the other for the *minutes*) so that every reporting of the minute is preceded by a reporting of the hour. The time is announced once every 4 seconds, thus 14 times in each minute. A few seconds before the minute is over the machine is cut off and a buzzer switched on for 3 seconds, so that the end of a minute can be marked exactly.

This represents a new service and a unique application of electronic devices.

SERVICE EQUIPMENT APPROVED FOR F.H.A. LOANS

SERVICE Men will be interested to learn that certain types of servicing equipment were approved, last month, for financing by the Federal Housing Administration!

The Precision Apparatus Co. was among the first to have its units approved for financing under the above plan. Analyzers and tube testers made by this company are among the servicing components included.

Under this plan, dealers and Service Men can buy their equipment and pay for it over an extended period, just as repairs on homes, buildings, etc., are being financed by this Federal Administration.

Right. Amateur radio maintained its reputation of helping in time of emergency. Below. Some radio service equipment can be financed under the F.H.A.



VERIFICATIONS TO BE DISCONTINUED

OF interest to the DX fan is the decision made last month, by two well-known operators of radio broadcast transmitters, to discontinue sending out the usual verifications of reception.

It is to be regretted that the Westinghouse Company which operates W8XK and W1XK short-wave stations, and the British Broadcasting Co. which operates the short-wave transmitters in England, found it necessary to discontinue this service to their listeners in far-off lands.

The announcement of the Westinghouse Co., explained that newspapers and magazines now carry listings of short-wave transmitters, their frequencies, and program schedules. The increasing volume of mail, it added, also makes acknowledgment impracticable.

AMATEUR RADIO SAVES INFANT

AMATEUR radio again came through nobly last month, in an emergency. On a small island in the Pacific Ocean, 75 miles out from Los Angeles, a tiny four-months-old girl was ill and in need of medical aid. The only communication from the island, which is known as San Nicolas Island, to the mainland is by means of an amateur radio station—W6JLF—operated by I. P. Elliot.

Elliot made contact with another amateur at Redondo Beach who called the local police. The latter notified the Los Angeles police and the Coast Guard—and by the time the police reached a doctor, a Coast Guard Patrol Boat was ready to sail.

Before morning, the boat, carrying the doctor, hove-to on the lee side of desolate San Nicolas Island and another mark was chalked up on the already enviable record established by amateurs.



IN REVIEW

Radio is now such a vast and diversified art it becomes necessary to make a general survey of important monthly developments. RADIO-CRAFT analyzes these developments and presents a review of those items which interest all.

"RADIO FADING" AND SUN GLOW

BRIGHT hydrogen eruptions from the sun corresponded with the major radio fade-outs during this past year, according to a statement made last month by Dr. R. S. Richardson of the Mount Wilson Observatory.

Four remarkable fade-outs of radio transmission were noticed at intervals of about 54 days and it was suggested by Dr. Richardson, that some form of unusual solar activity might be responsible. Spectro-heliograms (in other words—special photos) of the last two fading periods which lasted about 15 minutes each, showed in each case a strong eruption of glowing hydrogen—known as a "flocculus." Dr. Richardson based his statement on these records.

The careful study of such phenomena will eventually result in much better knowledge of radio transmission.

RADIO REPORTS AERIAL MANEUVERS

THE short-range characteristics of ultra-high frequencies in the neighborhood of 35 mcs. have just been put to a new and interesting use by the well-known flier, Major Al Williams.

The installation, which was completed last month, is the first of its kind to be used in an airplane. It consists of a 5-watt transmitter and receiver installed in the plane, with similar equipment located on the ground.

Major Williams uses this set-up to demonstrate difficult aerial maneuvers to aviation students and spectators, at various air fields. He converses continually with an announcer on the ground, explaining his movements.



INSULL BUYING RADIO STATIONS?

ACCORDING to a report received last month, Samuel Insull—one-time utilities magnate—is starting a new venture called the Affiliated Broadcasting Co. with which he hopes to band together some 26 low-power broadcast stations in Illinois, Wisconsin and Indiana.

Mr. Insull is convinced and has convinced many of the small-station owners that there is a real field for additional revenue by banding together.

However, an inquiry addressed to the Federal Communications Commission was answered very definitely that they (the F.C.C.) had no such information!

Among stations known to have been approached by the ABC are WCLS in Joliet and WWAE in Hammond—both have a power of 100 watts.

RADIO "SIGNAL 32" NABS BABE RUTH

AN amusing incident—and one which shows just how efficient the police-radio systems in large cities can be—took place last month, and involved no less a celebrity than Babe Ruth, baseball's "King of the Swat."

It seems that the Babe struck another car while driving home from Long Island, N.Y.; the damage was slight and he decided to proceed on his way.

However, the owner of the car which was hit thought differently, and before Mr. Ruth had crossed the Queensboro Bridge across the East River, he was greeted by an officer with a high-powered rifle. It seems that the police, not knowing who they were chasing sent out signal "32" meaning that the quarry might be dangerous!

The incident was settled peacefully.

Left. Major Williams uses short-wave radio for announcing how to "loop the loop." Below. Babe Ruth was greeted by police guns!



The "Pack" radio transmitter used to announce the results of an election.

"PACK" TRANSMITTER REPORTS BALLOT

THE engineering staff of station WLW found a new use for the portable "pack" transmitter which they designed and built a short time ago, in the experiment conducted last month in Cincinnati with the "proportional representation" method of balloting.

This suggests a new use to which such short-range transmitters will, no doubt, be put (F.C.C. permitting!) by other broadcast stations on similar occasions.

The transmitter, carried on the back of an announcer can be taken anywhere (where it is not possible to move the ordinary "mike" and line amplifier) thus facilitating the reporting of such events. The signals from the pack transmitter can be picked up at any convenient location by a receiver and then carried over land lines to the station. While the use of portable transmitters is not new, this application is certainly a new and novel one!

"CHECK VALVE" REDUCES "STATIC"

LATE last month, the American Radio Relay League announced a new radio device, which could be attached to the intermediate-frequency amplifier of any broadcast or short-wave superhet.

This device, which was described as a "balancer circuit," reduces to a great extent the interference caused by auto ignition sys- (Continued on page 614)

MUSICAL STATIC— INTRODUCING RADIO-CRAFT'S RUBBERBAND AMPLIFICATION

The static effect of stretched rubberbands opens up a new field for electronic experiments.

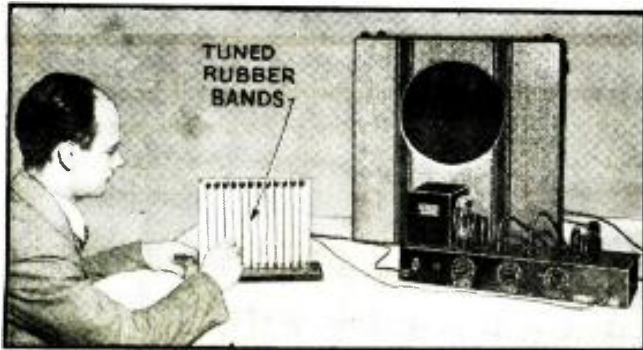
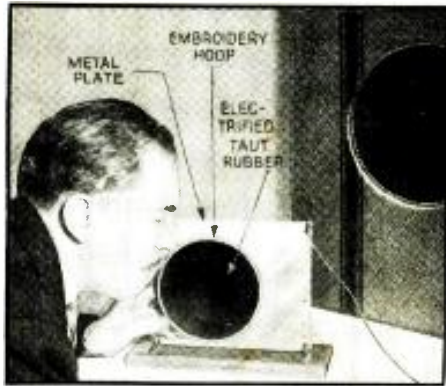

Fig. A, above. The "Band-O-Phone" in operation. Fig. B, below. The "static" microphone experiment.



A MOST unusual and interesting phenomenon was discovered recently by Messrs. K. G. Larson and J. J. Loop of Indiana University, and is described here in the first description which has appeared in any radio magazine. It was observed that when a stretched rubberband was plucked near the grid terminal of the first tube in an audio amplifier, the note was reproduced in the loudspeaker (see Fig. 1)!

With an amplifier having a voltage amplification of about 50,000 the note can be heard from the speaker even when the rubberband is plucked almost a yard from the grid terminal. However the effect almost, if not entirely, disappears when a neutral band (that is one without having a static charge on its surface produced by rubbing or stretching) is set in vibration by jerking. This indicates that friction or static electricity and not stretching is the actual source of the charge. We will discover more proofs later which also prove this statement.

After the phenomenon was noticed, a further study was made with electro-

scopes and it was found that when a neutral rubberband was drawn against the knob of an electrostatic scope, the electrostatic scope received a positive charge while the rubberband acquired a negative charge. Then, if it was immediately rubbed against the knob of a second electrostatic scope, the rubberband gave to this electrostatic scope its negative charge. It was further found that this charge can be neutralized and reversed by further rubbing. In all cases where a stretched rubberband was rubbed against such substances as wood, iron, brass, or copper it received a negative charge. Stretching a neutral rubberband near the knob of an electrostatic scope had no observable effect and a neutral stretched band did not attract small bits of paper. These experiments further proved that friction instead of stretching was the source of the peculiar charge which allowed the grid of the tube to pick up the tone. The results of these interesting experiments also suggested the possibility of combining a modern high-gain amplifier with this form of static pickup to develop practical applications.

NOVEL EXPERIMENTS

First a number of soft rubber objects such as bands, balloons, also pieces of paper, etc., were assembled.

A toy balloon inflated and held near the grid of the input tube produced some peculiar sounds, when rubbed with a hand or with such things as wood, wool, paper, etc. And when struck sharply with a finger, the balloon pro-

duced a sound closely resembling a kettle-drum. For convenience, a metal plate was used instead of the grid wire. See Fig. 2.

The production of such sounds immediately suggested the use of a stretched rubber diaphragm as a "static" microphone. So, a piece of thin rubber from a balloon was stretched between the hoops of an embroidery frame and held near a metal plate attached to the grid. At first the results were entirely nil, but when the rubber diaphragm was rubbed with wool or stroked lightly with a feather to charge it, the results were startling! When spoken into, the voice came from the

loudspeaker with about the same intensity as from a crystal mike, and though there appeared to be a marked resonance at the low-frequency end of the "voice band" this probably was caused by the natural resonant period of the stretched rubber diaphragm (See Fig. B).

This application as a microphone is different than that of any of the types ordinarily used since it works entirely as the result of a static (not "capacitative") action. The fact that the signals or currents were as strong with the grid wire as with a metal plate proves this!

This success with taut rubber as a microphone led to experiments with musical instruments—using the effect to pick up sounds directly and convert them into electrical currents, without the use of a microphone, or pickup. (Continued on page 613)

FOR THE
FIRST TIME
IN ANY
RADIO
PUBLICATION

Fig. 1
Plucking a rubberband near the grid lead produces a tone in the loudspeaker!

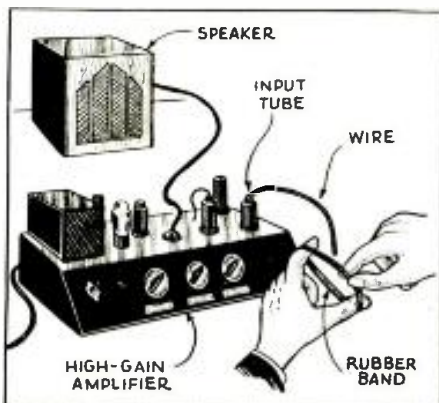

Fig. 2
A toy balloon held near a metal plate makes a new type of microphone!

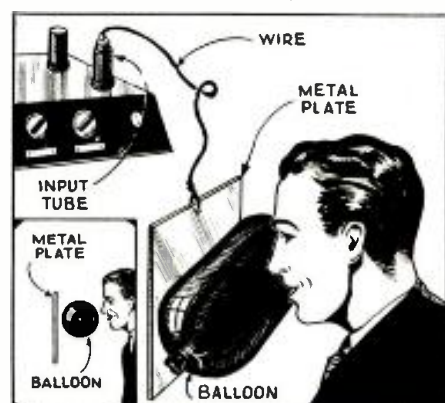
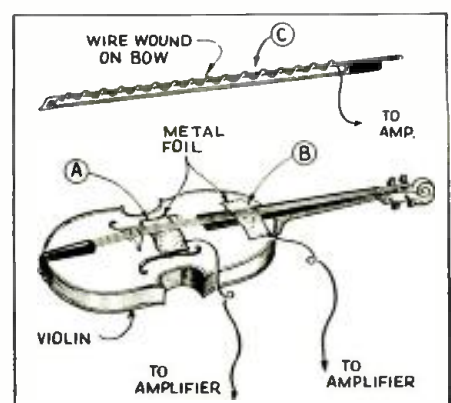

Fig. 3
Direct pick-up of static (friction) currents permits amplification of violin music.



MAKING A "PERSONAL" SET FOR THE BLIND

This A.C.-D.C. metal-tube set was designed to suit the special needs of a blind person—a personal set. It has many features.

C. W. PALMER

SPECIALIZED radio sets have been gaining favor in recent years, as evidenced by the development of all-wave sets for the home; portable sets for the traveling man; auto sets for the motorist; communication receivers for commercial radio communication, etc.

However, this specialization is only in its early stages of development and we will no doubt find many types of receivers to fill many different needs as they originate.

RADIO HANDICAPS OF THE BLIND

One such need is in homes where a blind person resides. In such homes an unusual condition naturally exists. The

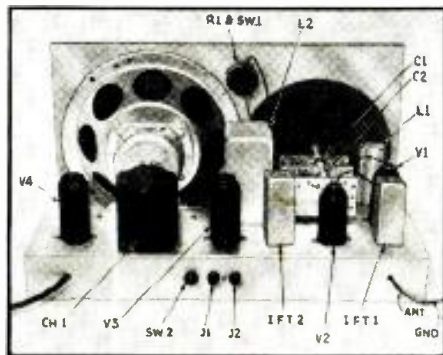
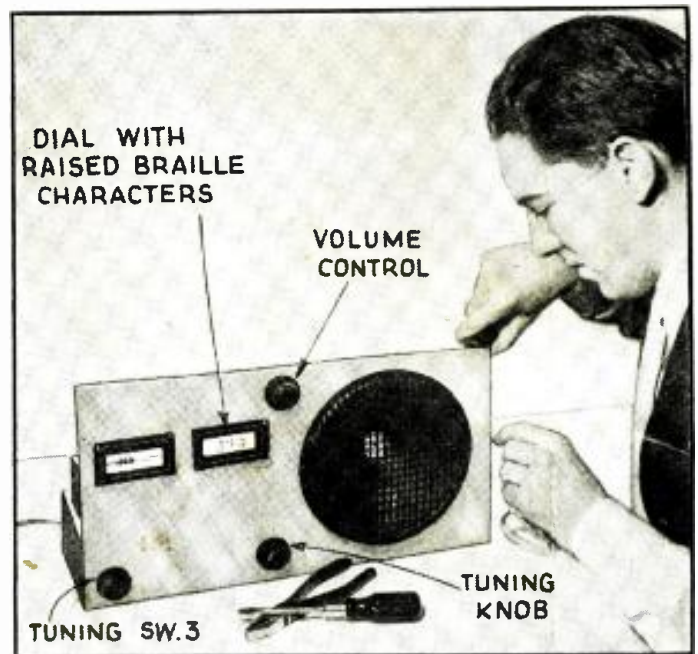

Fig. 8. The back of the set showing the positions of the parts "above board."

Fig. A. This set has both braille and roman numerals—switch tuning of local stations, iron-core coils—phone attachments—tone control, etc.



blind person has difficulty in tuning to a particular station because of a lack of some reference point which will permit tuning to a desired spot on the dial. Also, the blind person depends on radio for most of the entertainment he or she enjoys, which means that the radio set is operated for many hours of every day, and this might cause annoyance to other members of the household.

Also, there is a second possibility that the listener may have affected hearing as well as sight. In this case, the volume of the radio set would be excessive for the other occupants of the house or apartment.

The receiver described here has been designed to overcome all these possible annoyances, so that the blind person can fully enjoy the news, recreation and educational possibilities afforded by modern broadcasting facilities. First, the tuning problem is solved by using a special dial having raised "braille" numbers on one scale—thus telling the setting to which the receiver is adjusted. And to further facilitate tun-

ing the local stations, a switch of the rotary type is arranged with pre-set condensers so that 5 of the local stations can be tuned-in simply by rotating this switch! Other stations are located by means of the raised braille numbers. (These characters, embossed on special pasteboard, were made available through the kind cooperation of the American Foundation for the Blind.)

And for listeners who are blessed with sight, a second scale on the tuning dial supplies the usual roman numerals of frequencies in kc.

The second problem is solved by the addition of 2 phone-tip jacks for a pair of headphones to be plugged in, and a switch to cut out the loudspeaker if desired, so that either the phones and speaker, or the phones alone can be used.

THE CIRCUIT

The receiver incorporating the above features is a (Continued on page 616)

Fig. 1. The circuit and values of the superhet. The volume control resistance may be 25,000 ohms as specified in the list of parts.

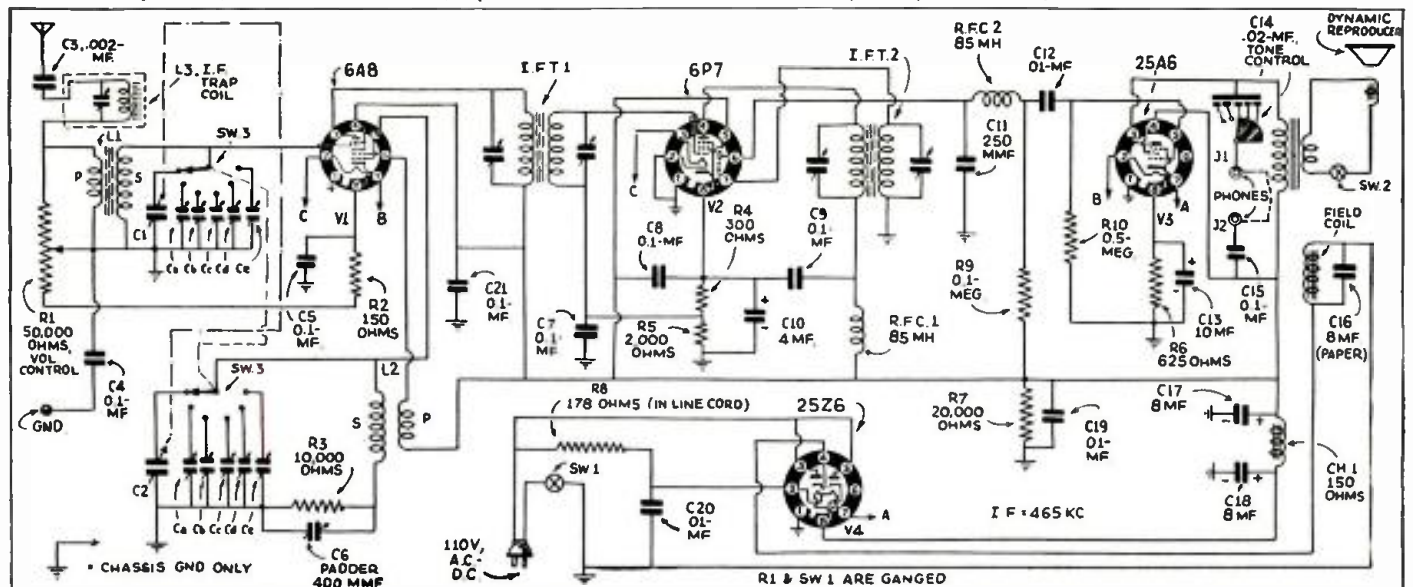

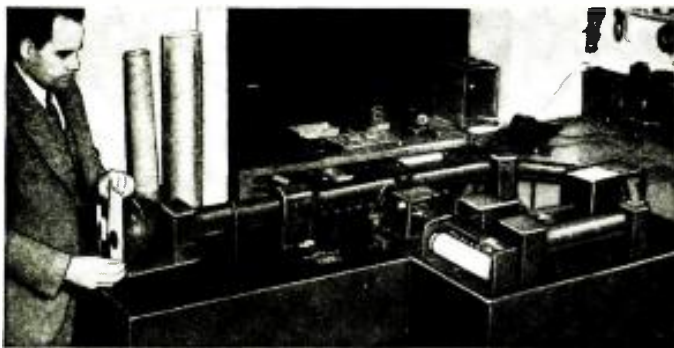

Fig. A. A PE. cell is used in the Spectrophotometer. (G. E. photo)

NEWEST APPLICATIONS OF ELECTRONICS

Some of the very latest photoelectric developments as they are used in industry are here described. Learn the principles of operation of the Spectrophotometer; the production of "Audible Light," and the functioning of the Water Locator.

HOWARD G. McENTEE

PHOTOELECTRIC devices have been finding more and more applications in industrial and laboratory procedures. In fact, the electronic "eye" has become one of the most important adjuncts to the many inspecting and counting operations involved in quantity manufacturing, whether the product is paper, cigars, tin can wrappers or beans!

A few examples of such laboratory and industrial photoelectric methods, as well as a few applications of other electronic devices of unusual interest are described here to give readers an idea of the trend of development in these closely allied fields.

THE "SPECTROPHOTOMETER"

In Fig. A is an instrument called a photoelectric spectrophotometer. It is used to quickly and accurately analyze the color make-up of a wide variety of materials. A sample of the object or material to be so checked is placed in

the machine and in less than 3 minutes a chart is made showing the wavelength of each color of light reflected by the sample as well as the "quantity" of each color in the color make-up!

The exact composition of any color in dyes, inks, paints, etc., is often confusing. For example there are blue-blacks, brown-blacks and red-blacks; while actually there is very little black coloring matter made which is "pure" black. Similarly, there are wide variations in whites—and in other colors. Such color analyses are made easy with the spectrophotometer.

The photoelectric spectrophotometer shown in Fig. A, consists of (a) a monochromator which is an instrument used in physics labs. for accurately breaking light into its component color parts; (b) a photoelectric photometer which measures or indicates the quantity of each color of light; and (c) a drum recorder which makes graphs of the findings of the photometer. By a skillful method, the individual discrepancies of the instruments are balanced out, thus producing very accurate results. A circuit of this instrument is shown in Fig. 1.

AUDIBLE LIGHT

If you were to address yourself to a beam of light and then keep your eyes on a distant spot where that beam was focused, would you be surprised to hear your voice repeating what you said?

This is another accomplishment of the PE. cell. Any experimenter can demonstrate to himself how this is accomplished, by connecting a PE. cell to an A.F. amplifier and holding an

electric light bulb in front of the cell. If the light is operated from the 60-cycle power supply line, a loud hum will be heard from the reproducer. This is the 60-cycle hum produced by the variations in intensity (modulations) of the light from the bulb.

And if the experimenter wishes to go further, a diaphragm having a highly-polished back can be set up as shown in Fig. 2 so that light from a bulb (operated from D.C.) is reflected into the PE. cell. Now if you talk against the diaphragm, (Continued on page 615)

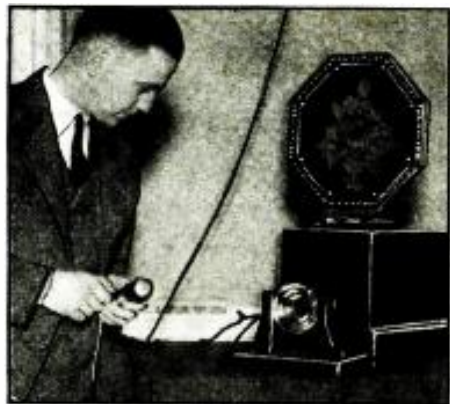

Fig. B, above, production of the so-called "audible light." Fig. 2, below, the circuit used. (G. E. photo)

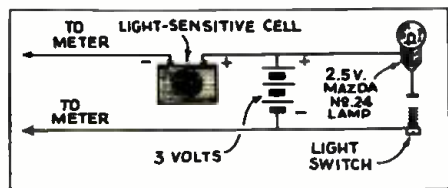
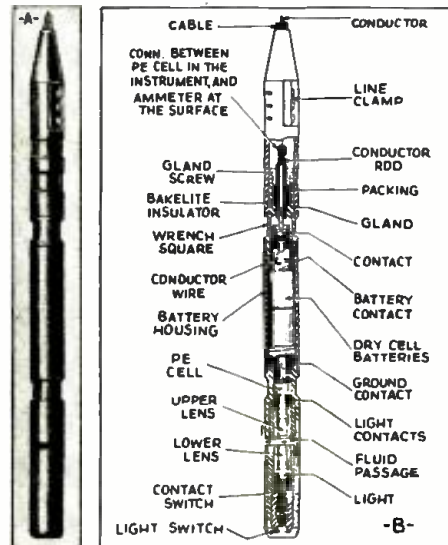
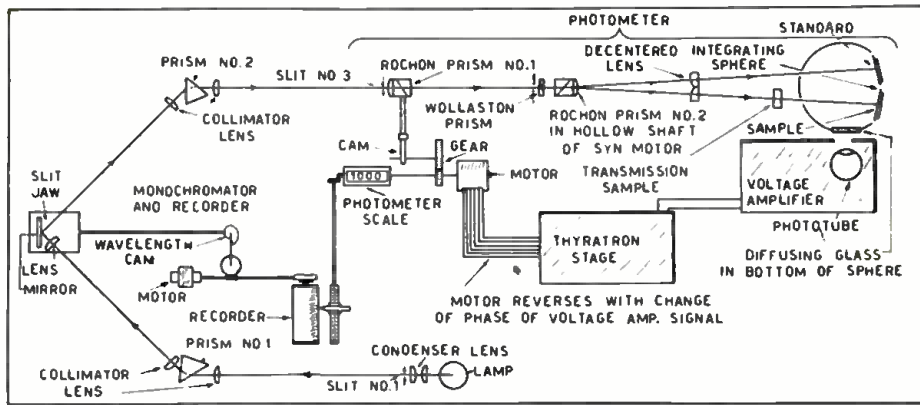
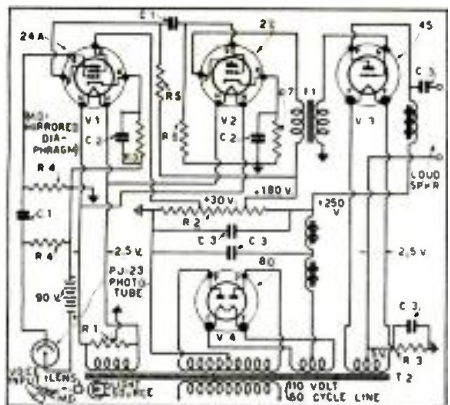

Fig. 3, right above, cutaway view and outside view of the water locator. Fig. 4, right, the circuit. Fig. 1, below, spectrophotometer circuit. (Dale photo)



HOW TO MAKE A "MAGIC EYE" OUTPUT INDICATOR

Here is an electronic instrument which should prove to be invaluable for the Service Man and experimenter.

CHARLES SICURANZA

THE ELECTRONIC output meter is a device which should find ready acceptance among the service fraternity. It is not only a useful tool for the shop, but can be carried and used anywhere, because of its compactness, light weight and ruggedness. Like its big brother, the cathode-ray oscilloscope, this unit operates electronically, which means no moving parts, no inertia, no time lag, and no appreciable load imposed on the circuit under test.

The unit which is about to be described was built to take the place of the conventional output meter.

The miniature cathode-ray tube, designated as the 6E5, can be utilized in a number of ways. This unit, in addition to its use as an output meter, can also be used as a tuning indicator or voltmeter.

In order to understand how the unit operates as a whole, it is necessary to know how the 6E5 is constructed, and how it functions. The tube is built essentially like the bottle-shaped type 76 triode with a 6 V. filament. In the neck of the tube above the triode, there is mounted the convex-shaped electrode, designated as the *target*, which glows green when the tube is operating. The *cathode* extends up through the triode, into and above the target and terminates in a small black *shield* at the very top of the tube (as described in December, 1935, *Radio-Craft*).

HOW THE "MAGIC EYE" FUNCTIONS

The 6E5, so-called "magic eye" or cathode-ray tube functions in the following manner: with the tube heated and a voltage between 200 and 300 applied to the target, the electrons from

the cathode bombard the entire surface of the target which glows green because of the fluorescent coating on its surface. Attached to the triode plate and extending into the target compartment is a small vane designated as the *ray-control electrode*. This vane is positive with respect to the cathode and mounted very close to it. Now, referring to the sketch (Figs. 1A and B), it will be apparent that this vane will absorb a certain portion of the cathode electron stream, thus leaving a portion of the target surface in darkness. The angle of shadow varies from 90 deg. at zero bias, to zero angle at -8 V. applied to the triode grid of the 6E5.

It is easily seen that any variation in grid bias affects the plate voltage and plate current, and since the vane, or ray control, is directly connected to the triode plate, it absorbs more or less electrons, which in turn controls the width of the shadow on the target.

Now that we know how the tube works, we can see that applying a *negative D.C.* voltage to the grid of the 6E5 would *close* the shadow, and applying a *positive* voltage would spread it *wide open*.

Applying an *A.C.* voltage on the grid of the 6E5 causes the shadow to *flutter* (open and shut) in step with the frequency of the applied voltage.

A curious pattern is obtained with *A.C.* voltage (see Fig. 1C), namely: there is the bright portion of the target, then the slightly darker segment which represents the positive peak voltage, another segment even darker, representing the average value, and finally the darkest portion which actually represents the maximum *negative* peak

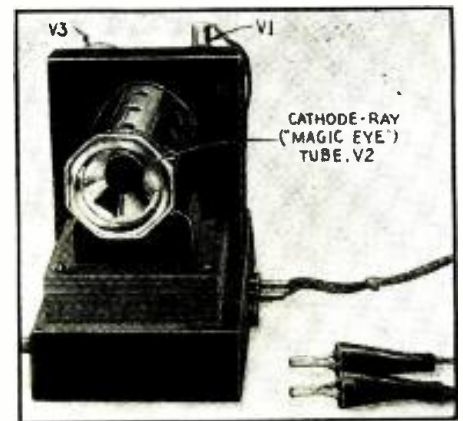

Fig. A. The front view of the "eye."

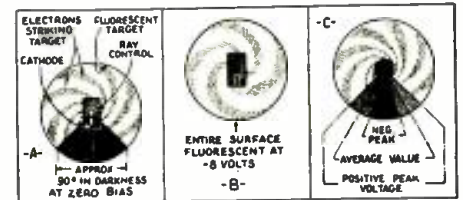

Fig. 1. The different actions of the 6E5.

voltage. Of course, the voltages mentioned above should not exceed 10 V.

Referring to the circuit schematic, it will be noticed that the 6E5 is coupled to a 6B7 tube which serves as a voltage amplifier and diode rectifier. The purpose of the 6B7 is to boost very weak voltages to the point where a satisfactory swing is obtained on the 6E5 grid. The diode rectifier receives the amplified *A.C.* voltage and converts it to pulsating *D.C.*, which is filtered into smooth *D.C.*, before it is applied to the 6E5 grid.

The power supply is of the conventional type using choke input for good regulation.

Three tip-jacks are provided for high- and low-voltage input with the center tip-jack as the common point.

A shielded lead with small clips and phone tips is used to prevent stray magnetic fields from affecting the width of the shadow. (Continued on page 618)

Fig. B, right. The rear of the unit showing locations of some of the parts.
Fig. 2, below. The circuit of the complete tester, with values.

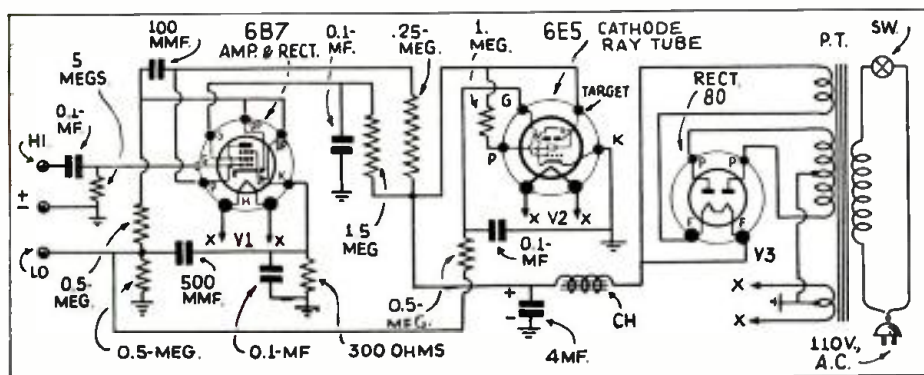



Fig. A. The complete instrument in operation.

WE HAVE HAD machines that could talk and sing, pictures that could vocalize, and now we have given the musical keyboard a voice. In connection with the development of the "Poly-Tone" photoelectric musical instrument it long ago occurred to the writer that to play actual words in conjunction with electronic music would greatly add to the effect.

After considerable thought and research, an instrument has been devised that will utter words which may be accompanied with sustained or percussion musical tones produced by rotating a series of light slits over various wave patterns as described in my "Poly-Tone" article in *Radio-Craft*, May, 1934.

Since it is possible to record any sound by the method used in talking pictures, suppose we consider just what a "singing keyboard" can accomplish. Since beautiful photoelectric music with sustained and percussion qualities is now an established fact, the matter of accompaniment may be considered as commercially available. But how are we to add modulated words and what effect will these words produce after we have created them?

THE KEYBOARD TALKS AND SINGS!

Making a keyboard talk or sing is not so simple a matter as may at first be imagined. To make the keys and photo-cell play good organ music was not easy either, but it has been accomplished and the buying public is destined to enjoy an entirely new treat when these photoelectric organs are made commercially. The talking and singing keyboard, together with electronic music, will place instrumental keyboard music on an entirely new plane; with new voice qualities and choral effects.

For the moment I have contented myself with having the standard chromatic scale keyboard utter a certain selected number of words. In the first model, an ordinary piano action was commandeered and some liberties taken with

THE SINGING KEYBOARD

Here is an entirely new electronic musical instrument which is described for the first time in *RADIO-CRAFT*. It has many applications, especially in talking-movies.

FREDERICK M. SAMMIS

it in order to provide the operations necessary for the work in hand.

In the motion picture business in Hollywood there has come into use a machine called the "Moviola." This machine is actually a diminutive talking picture sound-head adapted particularly to the needs of the cutting rooms of the various talking picture studios. I came out to Hollywood in rather a hurry in 1929 to head up the talking picture equipment business for RCA and continued in charge of that work for some years. One of my first privileges was to assist in making the Moviola a better instrument, or, in other words to make it talk louder and plainer, so that picture and sound track cutters could cut the sound track quickly and accurately to fit the cut picture. It is, doubtless, generally understood that the picture and sound are "shot" separately, cut separately, and only combined on the release prints heard in the theatre.

To make a keyboard sing and talk many problems were faced before we could even arrive at "first base." The means for producing the words which we wished the keyboard to utter were already at hand but how could we bring these recorded words into play just when we wanted them and only then;

that was the real obstacle. Naturally, a recorded film sound track bearing the desired words was necessary. Also it was obvious that the above-mentioned Moviola would reproduce these words—yet, these questions arose: How were we to release these words when any key was touched; how were we to start the word from the beginning only? How were we to prevent the words from repeating themselves over and over again, or as long as the key was held down?; etc., etc.

No form of rotating or continuously-moving sound track seemed to fulfill these requirements. Reciprocating sound tracks were resorted to and immediately produced the desired results. There was still a fly in the ointment, though. True, the depression of any key caused a sound track recording of the word to be drawn over a light slit and between the usual exciter lamp and light sensitive photo-cell, and the word then would be spoken by the loudspeaker; but when the key was released, the film track would travel back over the same light path and not only mess up the word itself by saying it backward, but it would interfere with the music and other succeeding words as well!

Bear in mind that in order to produce a practical (Continued on page 617)

FOR THE
FIRST TIME
IN ANY
RADIO
PUBLICATION

Fig. 1. The "talking keyboard" attached to a "Moviola," the sound head of which is shown over the keyboard. The detail at B shows the film film holder and shutter employed.

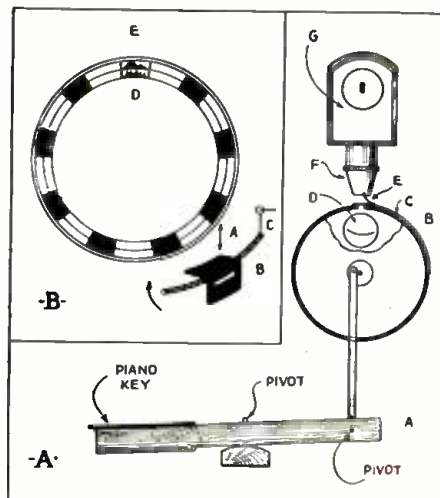
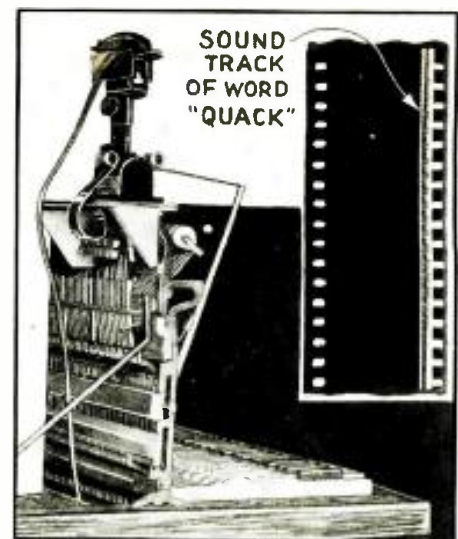

Fig. B. A detail of the keyboard mechanism and a typical example of the film strips used.



OPENING DOORS AUTOMATICALLY

A new device operating with a grid-glow relay tube which is positive in action and low in cost. It will find many practical uses.
HARRY F. DART

AUTOMATIC DEVICES for opening garage doors already include those which operate from mechanical trigger arrangements and which are actuated by the influence of a headlight beam on a photo-tube. However, most of these types involve the use of a motor and other expensive equipment which swell installation and maintenance costs. A new method uses a cold-cathode grid tube. The circuit arrangement and mechanical equipment are so designed that the total installation is not expensive.

The main advantages of this system are (1) inexpensive equipment; (2) rapid operation; and, (3) low operating cost. Simple mechanical features involve two main pieces

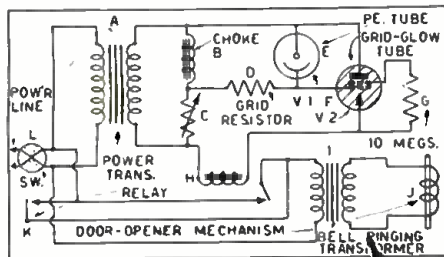
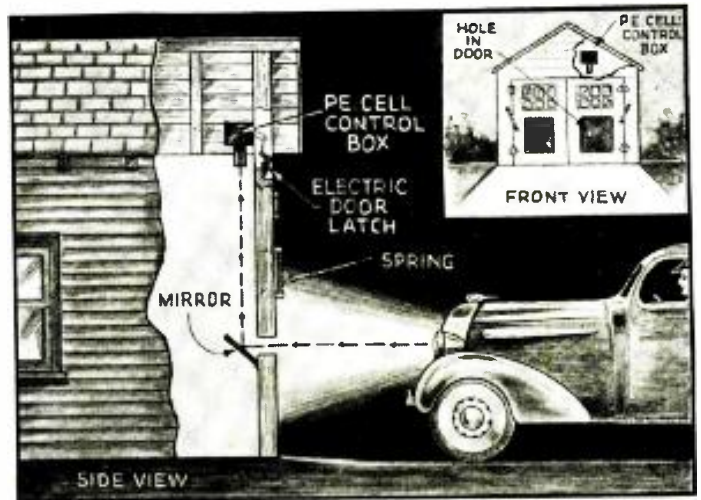

Fig. 1. The circuit of the door-opener mechanism is seen here. The photo-cell, grid-glow tube and relay serve to actuate mechanical devices.



of equipment. A door-opener, or *release*, is electrically operated and a set of springs mechanically opens the door.

The door-opener, like that commonly used on apartment house doors, may be placed on the framework above the doors. It is electrically operated so that the latch releases when current from a bell-ringing transformer flows through the winding. Catches on the doors should engage the opener and hold the doors closed. When an impulse is sent through the coil, it releases the latch, allowing the doors to open.

The mechanism which swings the doors open consists of heavy coil, door springs. They should be mounted along the hinged edges so that they can exert their full force against the doors as they are released. Since these springs generally are used to *close* doors, they must be installed opposite to the usual manner, so as to *open* the doors—(which previously had been manually closed).

(Continued on page 618)



Fig. A. The completed electronic relay system in operation. A movement of the hand controls the window lights.

HERE IS a piece of electrical magic that will draw a crowd to a radio dealer's show window. It enables people on the street to turn on an array of lights or an electric fan, or to start a toy electric train in the show window, merely by placing a hand close to the window glass. The device is easy to construct and the cost of the parts required is small.

The circuit (which was designed by Mr. F. G. Shepard, Jr., of *RCA Manufacturing Company*) is shown in the diagram. It operates on the increase in output of an oscillator, caused by an increase in the oscillator's feedback capacity when a prospective customer puts his hand near an "antenna," or capacity plate, in the window. The

AN A.C.-D.C. ELECTRONIC RELAY

Radio dealers and Service Men will find this simple circuit an exceptionally fine way to attract customers to their store windows. Very effective displays can be made.

HERBERT M. NEUSTADT

triode section of the 6Q7 is the oscillator. Feedback depends on the capacity, represented by C1 in the diagram, between the antenna and ground. If a hand is brought close to the antenna, this feedback capacity is increased and the output of the oscillator rises. The diode section of the 6Q7 rectifies the 6Q7's triode-section oscillator's output and applies to the control grid of the 25A6 a D.C. voltage, the magnitude of

which depends on the strength of oscillations. When someone in front of the window places a hand close to the antenna, the negative bias on the control-grid of the 25A6 is increased by the increased output of the oscillator. This causes the plate current of the 25A6 to change sufficiently to operate the relay which controls the display.

This circuit is capable of performing with extremely (Continued on page 613)

Fig. 1. The schematic circuit of the oscillator and relay. Resistor R2 controls the sensitivity of the device. Two new metal-tube types are incorporated in this useful device.

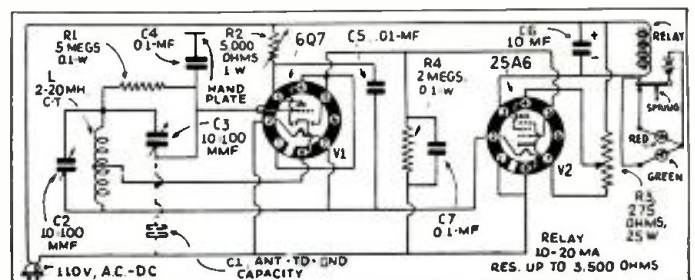

RADIO PICTORIAL

Robot Telephone Operator; Irving Berlin Uses "Home Recording"; Prison's "Tin Stool Pigeon"; Dial-Tuned Transmitter; Mobile Television Transmitter; X-Ray Test for Pipe Flaws.

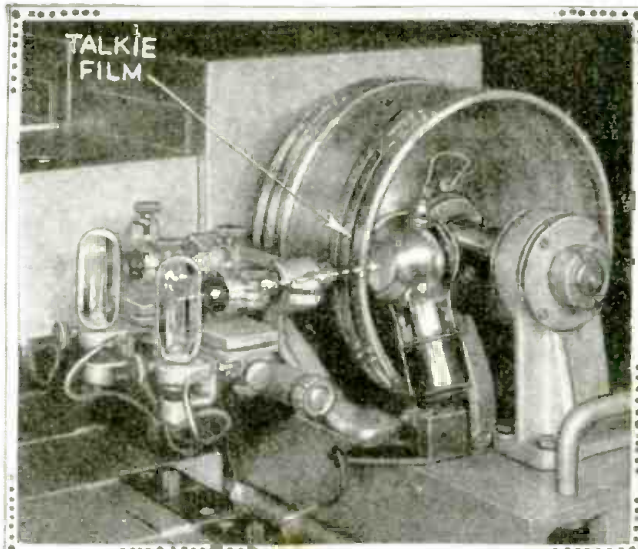

ROBOT TELEPHONE OPERATOR! This apparatus is used to transfer dialed numbers to an audible ("voice") reproduction of the same number. The 10 digits and the party letters are recorded on film strips on revolving drums. A photo-cell inside each drum picks up the impulses. The apparatus is used in the Bell System. (Bell Labs. photo)

IRVING BERLIN records new numbers on this equipment to check his latest songs! (Wide World)



DIAL-TUNED TRANSMITTER! The automatic dial shift system of this unit can pick any one of 10 frequencies at the will of the operator. The power output of this equipment is 400 W. The range is 2 to 18.1 mc., and the dial causes the correct changes to be made in every necessary circuit almost instantly. The transmitter is intended for ship-to-shore or aviation use.

(W. K. Co. photo)

A TWIRL OF THE DIAL SELECTS ANY ONE OF 10 FREQUENCIES!

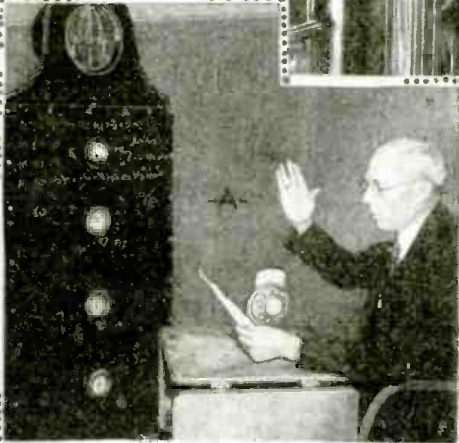
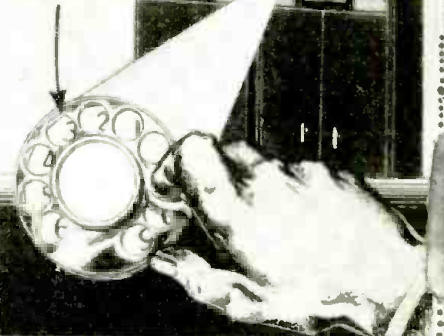

PRISON'S "TIN STOOL PIGEON." This name is applied to the equipment used at the Wash., D.C., Reformatory. Left, Superintendent Peak talking to the prisoners through the many speakers (one is shown in Fig. 8—lower-right page corner). These speakers, installed in dormitories, also function as microphones to pick up voices, etc., in the room. A prisoner perfected the equipment, just before his release! (Harris & Ewing)

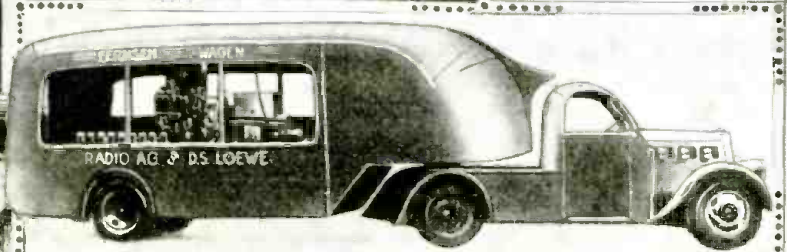

MOBILE TELEVISION TRANSMITTER. This truck is sent to the scene of important events and the latter are recorded on film. This film is then scanned and broadcast by a transmitter also contained in the truck. Equipment is also carried by which the film may be projected on a screen on the rear of the (German) truck. (RPS)

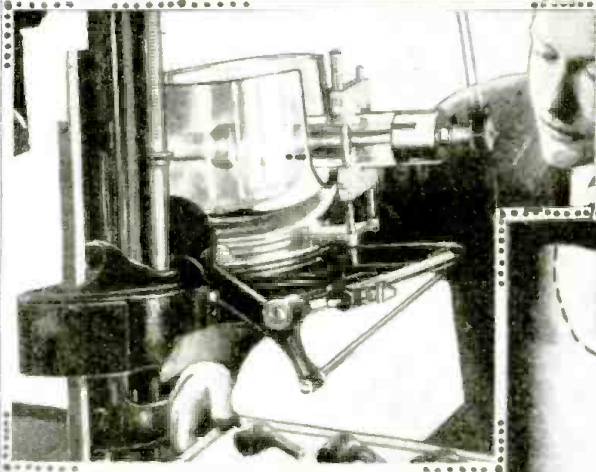

X-RAY TEST FOR PIPE FLAWS. A famous pipe maker uses the X-Ray to test all pipe bowls for flaws. The equipment is shown above, while at right is a view of a bowl with prominent flaw. A large amount of the briar root used for pipe-making contains hidden imperfections which make it useless for this purpose. The flaws are often pebbles, which ruin the cutting knives.

(Kaywoolfe photo)

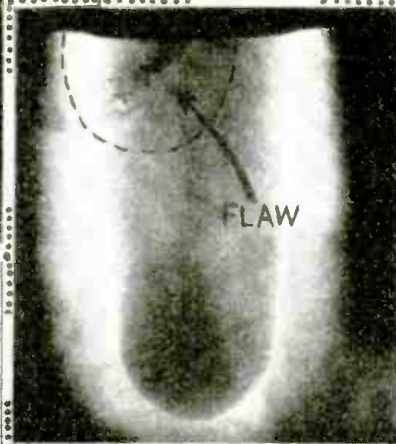

"RADIO" POSTAGE STAMPS FOR THE PHILATELIST

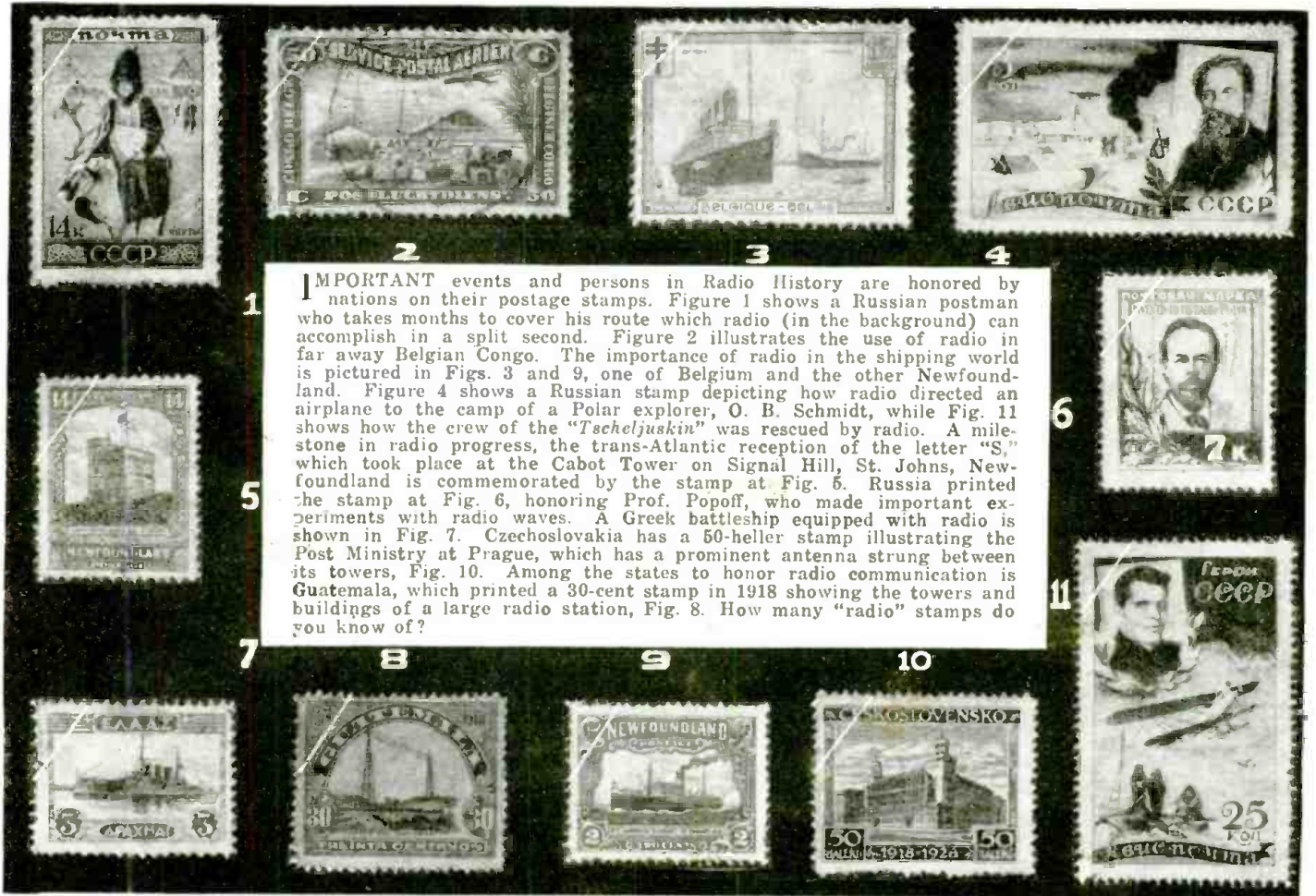

IMPORTANT events and persons in Radio History are honored by nations on their postage stamps. Figure 1 shows a Russian postman who takes months to cover his route which radio (in the background) can accomplish in a split second. Figure 2 illustrates the use of radio in far away Belgian Congo. The importance of radio in the shipping world is pictured in Figs. 3 and 9, one of Belgium and the other Newfoundland. Figure 4 shows a Russian stamp depicting how radio directed an airplane to the camp of a Polar explorer, O. B. Schmidt, while Fig. 11 shows how the crew of the "Tscheljuskin" was rescued by radio. A milestone in radio progress, the trans-Atlantic reception of the letter "S," which took place at the Cabot Tower on Signal Hill, St. Johns, Newfoundland is commemorated by the stamp at Fig. 5. Russia printed the stamp at Fig. 6, honoring Prof. Popoff, who made important experiments with radio waves. A Greek battleship equipped with radio is shown in Fig. 7. Czechoslovakia has a 50-heller stamp illustrating the Post Ministry at Prague, which has a prominent antenna strung between its towers, Fig. 10. Among the states to honor radio communication is Guatemala, which printed a 30-cent stamp in 1918 showing the towers and buildings of a large radio station, Fig. 8. How many "radio" stamps do you know of?

TELEVISION IN FRANCE

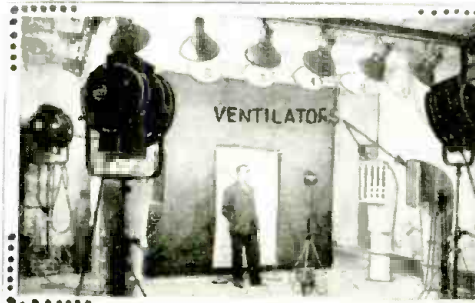

The large lamps needed for this work generate such heat that ship-type ventilators are needed! The air is cooled and humidified in a large chamber and piped under pressure to the studio.

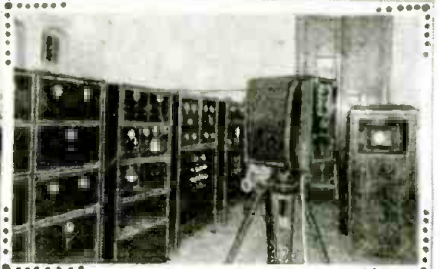
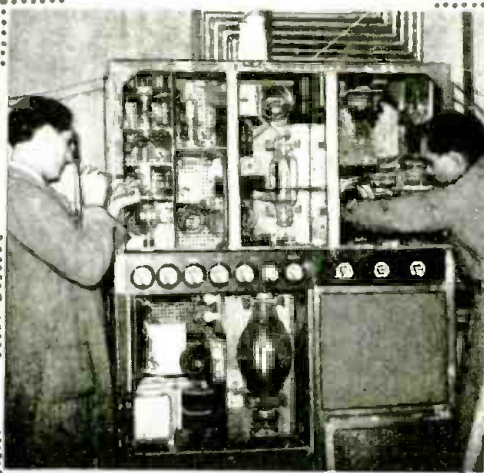

The transmitter room, with the control receiver at right. The television camera is in the center.



Directly above, a view of part of the transmitting equipment during the process of installation. The transmitter works on a wavelength of 8 meters, and has a power output of 1 kw. The studio is located at a distance of about 1 1/2 miles from the Eiffel Tower, where the transmitter and modulation units are located. A special cable is used to connect the two, while a concentric cable is used to connect the transmitter to the antenna. A carrier system is used between the studio and the transmitter, the operation frequency being 2 mc. The transmission is of the high-definition type, 180-line scanning being used, with 25 pictures per second. Two synchronizing pulses are transmitted, one at the end of each line and another at the end of each picture. Right, the cathode-ray tube and its equipment. Left, the high-frequency receiver. There are 6 receivers set up in Paris, for public demonstration purposes.

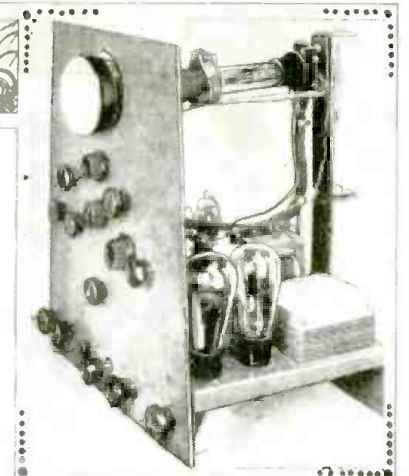

ELECTRONIC MUSIC FUNDAMENTALS

The subject of electronic musical instruments is one which has attracted many experimenters—it will interest you.

EDWARD KASSEL PART I

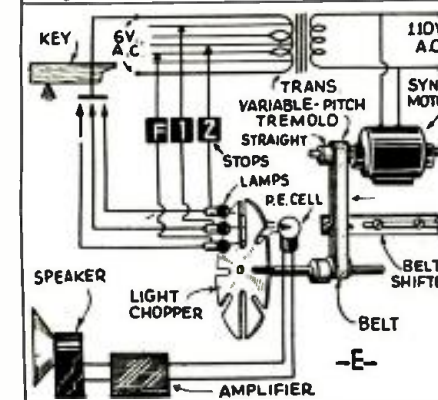
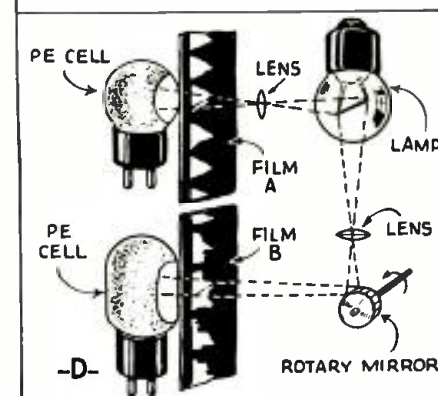
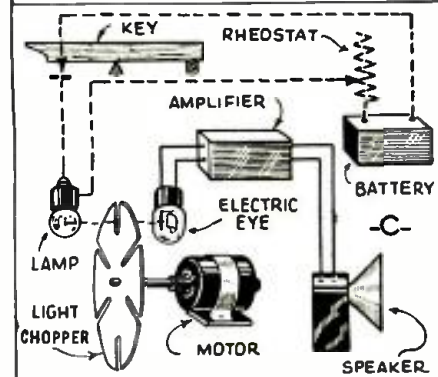
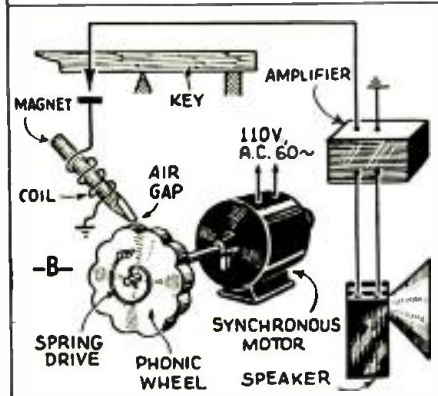
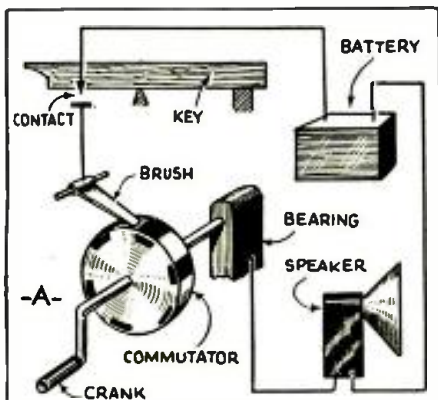

THE PRODUCTION and reproduction of sound energy with the aid of a *diaphragm* takes place every day in our lives, and this phenomenon is so widely used that we take it as a matter of fact. Huge industries have grown out of it, such as the telegraph, telephone, radio, sound moving pictures, phonographs, and the growing industry which is *electric musical instruments*. There are some 40,000,000 telephones, radio sets, electrical phonographs, P.A. systems, sound motion pictures, and other equipment containing diaphragm reproducers in the United States alone, today.

We hear sound produced by diaphragms when telephoning; also at the moving pictures; when listening to the radio; and when we play an electrical phonograph record, and we find them very satisfactory for the purpose.

ELECTRONIC MUSIC IS ON THE MARCH!

And now we are beginning to use this method for the production of musical tones and find it equally acceptable. It is unimportant how the diaphragm is set into motion by electrical means since the principle remains the same. It can be done by a stylus in a phonographic groove, by a sound track on film, by a voice speaking into a microphone, or by actuating electrical keys which send pulsations into the electric current driving the diaphragm.

The criticism of some conventional musicians has been unfavorable to electrical reproducers or to electrically-produced tones. However, naturally a

conservative person who has spent his whole life in playing a conventional instrument will hardly welcome an electrical tone-producing instrument, although such an instrument has been accepted by most, as an article of merit. It is hardly expected of an iceman to make favorable comment on electrical refrigeration. Electrical refrigeration, however, has found its place in homes and public institutions, and *electrical musical instruments are inevitably following the same course.*

"ELECTRONIC ORGAN" HISTORY

And now the electric musical instrument of the diaphragm type is appearing on the market after being in the experimental stage for more than 30 years. These instruments are now being built commercially and are opening new fields in all their branches, by radio technicians and musical-instrument builders.

There has been some discussion in musical magazines on the question of who was the first actually to produce and sell an "electronic organ" type of musical instrument. Careful investigation shows that the first commercially-made instrument was constructed under a contract awarded, by a Philadelphia broadcast station, to Ivan Eremeeff, chairman of the Society of Electronic Music, on July 2, 1933, and was delivered in the beginning of February, 1935. This instrument made its official debut on February 10, 1935, according to nation-wide press reports, and was officially pre- (Continued on page 620)

Fig. 1, left. Some of the methods for producing electrical music.
Fig. 2, below. A comparison of frequency ranges for various instruments.

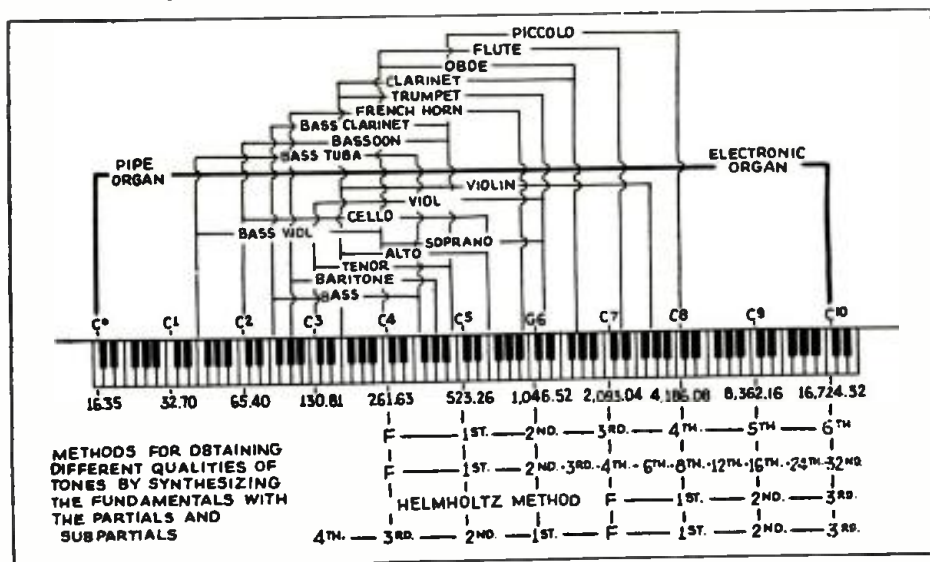

MAKING A COMPACT RESISTANCE-CAPACITY TESTER

Here is a unit for the Service Man and experimenter which will do many things that the ohmmeter will not do.

ALLEN BEERS

A COMBINATION ohmmeter, voltage drop and breakdown tester is shown in Fig. A.

This new device was developed by the writer as a means of securing the "low-down" on those resistors which, due to their location—such as in the grid circuit of resistance-coupled stages, A.V.C. circuits and some bias resistors—cannot easily be tested.

Here is a device which, in the course of giving a resistor a break-down test, will: (1) indicate how many ohms a resistor is off-value (and with greater accuracy than an ohmmeter); (2) allow a potential to be applied across a resistor, and permit the voltage drop in the resistor to be measured; (3) allow a variable load to be applied to the resistor in order to bring it up within a few seconds to its watts rating, and

then permit a voltage drop or resistance test to be made. The same complete test may be given to transformer or choke-coil windings.

The facilities permit a Service Man to quickly locate a noisy resistor or transformer winding; or one that is breaking down at intervals, thus causing the various "intermittent" troubles so common in present-day receivers.

The writer has seen resistors change in value or break down completely and in less than a minute, check OK again—according to an ohmmeter! What chance is there of this condition showing up on a resistance test, even if brought up to working temperature?

Referring to Fig. 1, voltages of various values are taken from a 10,000-ohm divider which is connected across the 350 V. D.C. (Continued on page 621)

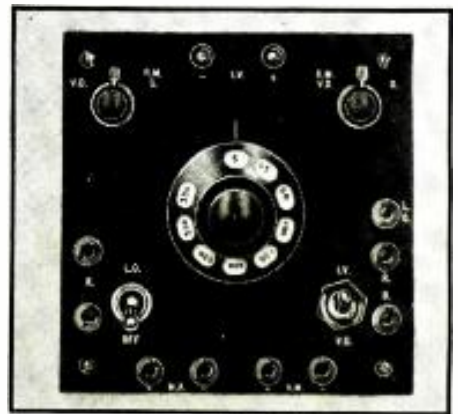
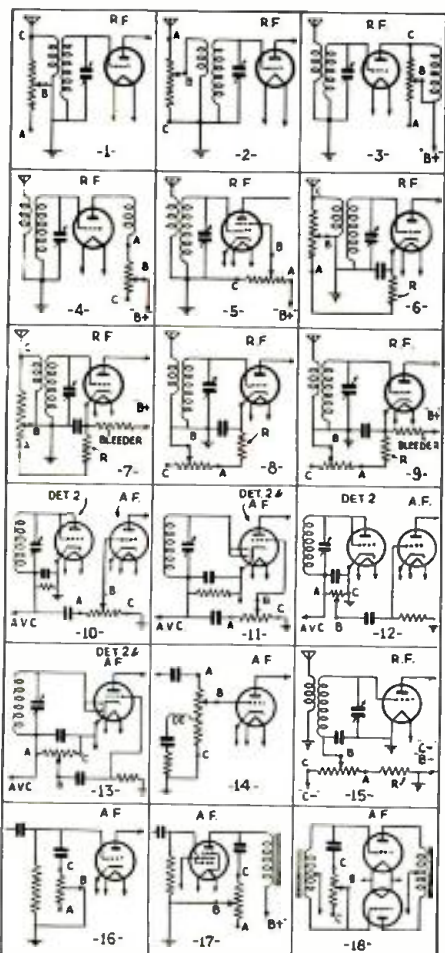
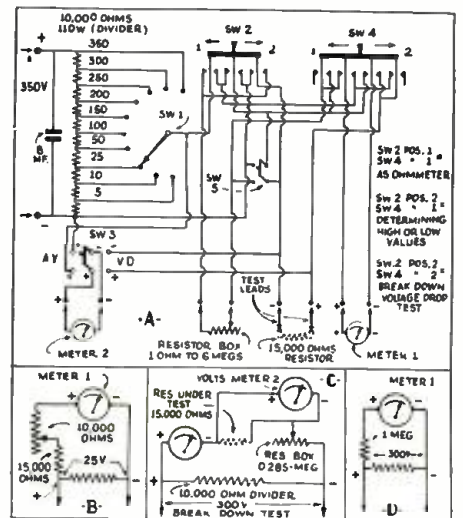

Fig. A, above. The front panel of the tester. Fig. 1, below. The circuit and details.



TAPERS OF MODERN VARIABLE RESISTORS

Do you know the taper needed for each particular type of volume control? Here is the answer to the problem.

IN MOST volume-control circuits, the taper of the variable resistor used is far more important than its maximum resistance.

Nevertheless, countless orders for variable resistors are placed every day with just the maximum resistance specified. If the order comes from a distance, the jobber must delay it several

days while writing for additional information or fill the order promptly with the taper he considers most universal. Should the taper so selected give poor service, the make of control is condemned rather than the method of ordering which was really at fault.

Several years ago the company with which the writ- (Continued on page 619)

Fig. 1, below. Graphs of resistors. Fig. 2, left. The 18 circuits.

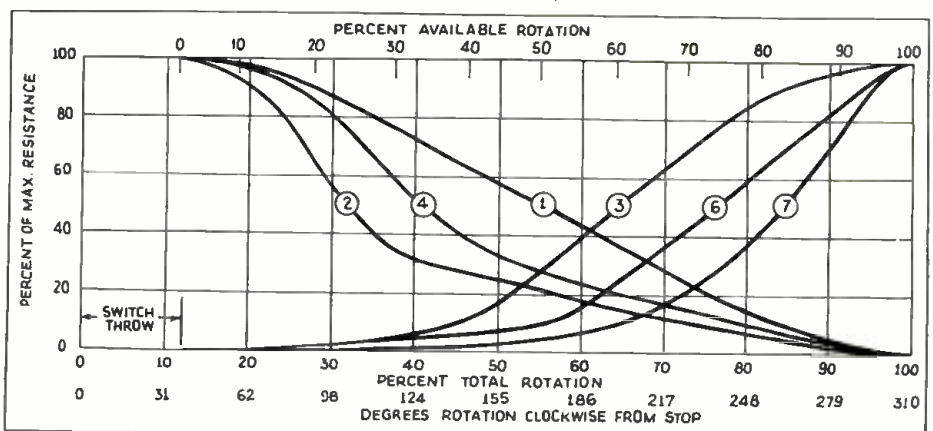

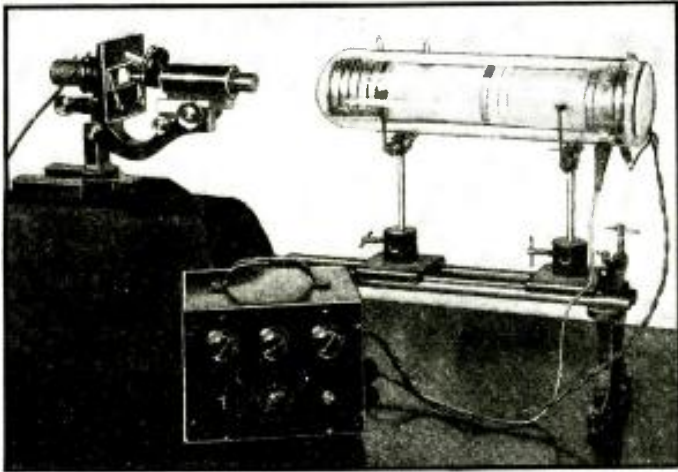

THE ELECTRON IMAGE TUBE

A new electron tube which has extremely interesting applications as a "dark light" telescope and microscope "copying camera" is described in this article.

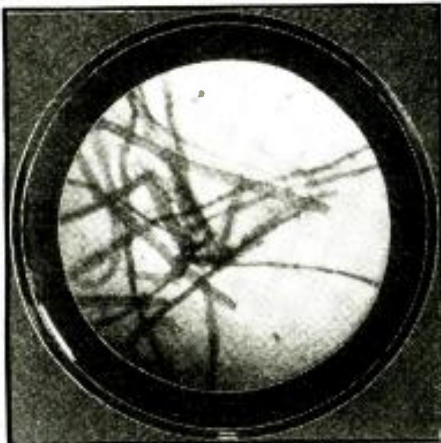

Fig. A, top. The image tube with a microscope.
Fig. B, above. A microphotograph made with infra-red light.

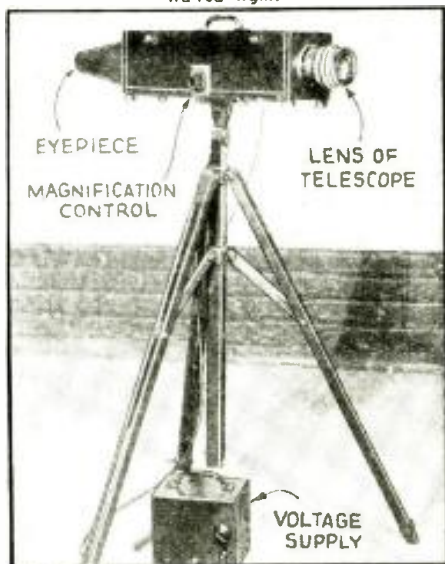

Fig. C, above. The image-tube telescope.
Fig. D, below. Movie-film view with "dark" light.



A NEW electron tube which is destined to make important changes in scientific and industrial optical methods was demonstrated last month by its inventors—Doctors V. K. Zworykin and G. A. Morton of the RCA Laboratories.

This new tube, which really starts a new branch of electronics called *electron-optics* takes the place of the usual glass eyepiece lenses of a telescope or microscope and does the work so much better than its glass cousins that there is little doubt of its future.

When used as a telescope (see Fig. C) the device will operate over both the infra-red or "dark light" portions of the light spectrum and the ultra-violet area. Thus, it has a much wider optical range than any glass lens. This permits the electron-telescope to see through fog and even perceive smoke or heat waves (that is, the infra-red radiation) in absolute darkness. (An example of this use is seen in Fig. D.)

And what is even more important, perhaps, it has the ability to change infra-red light rays into visible light which the human eye can perceive. This makes it an extremely useful piece of apparatus for long-distance photography, signaling, alarm systems and a war-time indicator of ships or planes approaching through fog, smoke or darkness.

When used with an "infra-red" microscope (as pictured in the cover painting and in the photo at Fig. A, at the head of this page), the electron tube becomes a particularly valuable instrument for the biologist, medical doctor and scientist. For when used in this way, its infra-red conversion to visible light permits examination of live and moving specimens which has been possible up to this time only through the use of stains and dyes which almost always killed the specimen. (A striking example of such microscopy is seen in Fig. B.)

The only method available to the scientist to accomplish this action, heretofore, has been the use of an infra-red microscope with a motion picture film sensitive to the infra-red spectrum. This method is so clumsy and slow that it is practically worthless for bacteriology.

But enough of what the tube will

do. There are without doubt many uses for this tube of far more interest and importance than those which have been thought of since its demonstration. These will become known when the tube has reached the "production stage."

HOW IT WORKS

The optical similarity between electron actions and the actions of glass lenses has been known since the time when the early Crookes tubes were used by scientists in developing the X-ray, cathode-ray, and other useful tubes. However, it was not until the cathode-ray tube was developed that this similarity was keenly felt. In the cathode-ray tube, if an absolutely flat-ended tube was made, it was found that the image was distorted due to a phenomenon which is known in optics as *spherical aberration*. By correctly shaping the fluorescent end-plate or "image plate," this distortion was almost eliminated—just as correctly grinding the glass lenses will almost eliminate the same effect. (Anyone who has looked through a lens at a distant object has noticed the view-distortion around the edges of the glass disc—this is spherical aberration.)

In the case of the electron-image tube, however, this effect was accomplished by shaping the photoelectric cathode of the tube in the form of a "dome."

Let us take a look at a cross section of one of the tubes, so that we can learn just how the remarkable effects mentioned above can be obtained. In Fig. 1, we see two of these cross-sectional views.

In the cross-sectional view at Fig. 1A, we see a photoelectric cathode on which the optical image or view is impressed, and a series of focusing rings (anodes).

THE TRANSLUCENT CATHODE

Let us digress for a moment and consider the photo-sensitive cathode. In the early days of photoelectric cell design it was believed that electronic emission could only be obtained from a photo-sensitive layer when the light beam was thrown directly upon the photo-sensitive layer and electrons (*Continued on page 622*)

NEW DEVELOPMENTS IN P. A. AMPLIFIERS

A new 35 W. amplifier having very desirable characteristics is described in detail. It uses metal tubes and develops a gain of 95 db.

THE AMPLIFIER described here was designed to take advantage of the benefits offered by metal tubes. It employs a high-gain circuit with an output stage consisting of 4-6F6s in push-pull parallel. Its rugged construction throughout and the fine quality of its reproduction make it particularly suitable for P.A. work.

As a starting point in the design of this amplifier, the requirements for a modern system were noted, namely:

- (a) High gain (sufficient for the new microphones);
- (b) High power output;
- (c) Low distortion (under 5 per cent);
- (d) Low hum level;
- (e) Simplicity of construction.

To take care of the low-output-level microphones encountered today, it was found that a gain of about 95 db. would be necessary. While this gain will take care of crystal and high-level velocity and dynamic microphones, a preamplifier should be used with the extremely low-level unit. To take care of the varied power requirements met up with in P.A. work, a power output of 35 W. was decided upon. The average amplifier available in the past to meet the specifications in the preceding paragraph would be quite a complex unit. However, through proper application of the new metal tubes, it was found possible to accomplish all this with only 3 stages, and on a single compact chassis in-



The appearance of the complete amplifier ready for use.

corporating newly-developed chromshield A.F. filter and power components.

THE CIRCUIT

Figure 1 illustrates the appearance of the final amplifier. Figure 2 is the corresponding wiring schematic. The unusual simplicity of construction and wiring is apparent at a glance. There is nothing tricky in the entire circuit. An input transformer is not mounted on the chassis due to the strong tendency toward the use of crystal microphones and high-impedance velocity mikes.

The input feeds directly into the first grid, with a 0.5-meg. grid-circuit volume control. Tube is a 6C5. This tube is an ideal voltage amplifier as it has an appreciably higher amplification factor than the 56 or 76 (20), and has a plate resistance of only 10,000 ohms, which means that practically the entire amplification factor is made available. This tube is parallel-fed and transformer- (Continued on page 617)

A very comprehensive summary of the equipment desired by a majority of Service Men as indicated by the recent Service Shop Contest conducted by RADIO-CRAFT

EQUIPMENT FOR THE SERVICE MAN

ALFRED A. GHIRARDI & I. ELLIN

THE AGE-OLD riddle, "Which came first, the chicken or the egg?", has a counterpart in the question, "Do radio test instrument manufacturers develop instruments first and then educate radio Service Men to use them, or are most new instruments brought out by the manufacturers only after the Service Men have made their needs known to them?"

It is generally conceded among the servicing fraternity that the former has been the case for quite some time. The test equipment manufacturers have really been more progressive and forward-looking than the rank and file of Service Men in this respect. They have developed test instruments and placed them on the market before most Service men really were aware that they needed them. We have only to cite the familiar, recent examples of the cathode-ray oscilloscope, the vacuum-tube voltmeter and the all-wave service oscillator to make this point clear. At this very moment there are thousands of Service Men who feel that they really need a cathode-ray oscilloscope in their shops. They think so merely because the ads. and publicity articles of prominent test in-

strument manufacturers have convinced them that this instrument is indispensable in their work—not because they really found out for themselves that it was necessary.

In view of this state of affairs, it was with a great deal of surprise and gratification that the judges of the "Ideal Radio Service Shop" Contest received over a thousand letters written by Service Men located all over the world, each one describing in great detail just what is his idea of an ideal service shop,

and exactly what equipment he considers necessary in order to do efficient, first-class service work on all the types of receivers he now encounters or will encounter in the near future. At last the Service Man has been induced to speak for himself—to express his own ideas on test equipment—ideas, by the way, which are borne of the actual requirements encountered in day-to-day servicing experience under all sorts of conditions. The seriousness with which these men put (Continued on page 624)

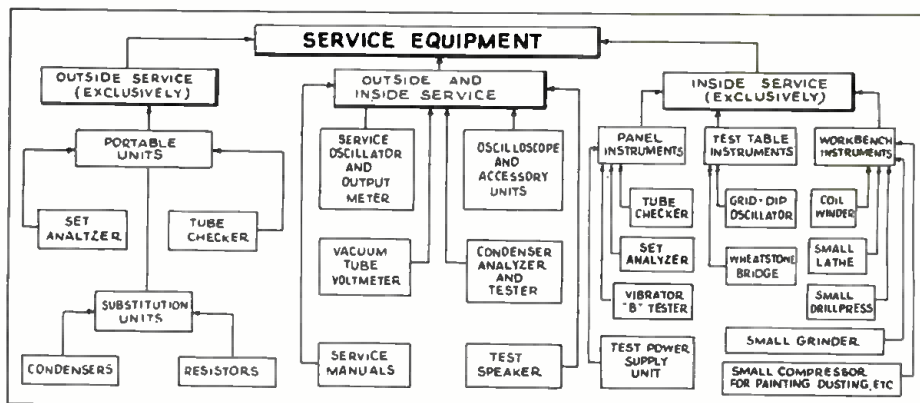

ANALYSES of RADIO RECEIVER SYMPTOMS

OPERATING NOTES

NOTICE

Notes should exemplify repeated faults in particular set models; illustrations should be included. Operating Notes must be based on use of perfect tubes.

Clarion Set: Kylectron Speaker Repair. The owner complained of a lot of crackles and loud bangs. Very little music could be received. I found the set had a Kylectron condenser-type electrostatic speaker. Further inspection revealed numerous sparks shooting all over the movable section of the speaker. I also found that the rubber sheet insulation between the foil on the one side and the stationary grid on the other side, was broken in many places.

There was only one way to repair the set and that was to replace all 6 sections of the speaker. This, I found, would cost far more than the customer wished to pay, so the speaker was repaired in the following way:

Disassemble the speaker and remove the foil-covered rubber sheets on each of the 6 sections; clean and save the cord that is inserted in the ridge around the frame to hold the rubber in place.

Next, procure 6 rubber baby pants similar to Fig. 1B, and cut them the size of the units, Fig. 1C. Then place the rubber sheets on the frames and use the cord to fasten it to the frame, Fig. 1A, stretching it at the same time. Make sure that the rubber is stretched evenly all around. If this caution is not heeded the speaker will rattle considerably.

Having placed the rubber in this manner the edges can be folded over and vulcanized with rubber cement.

Then coat the entire surface of the rubber with rubber cement. Also coat the foil sheets with the same cement. The foil should be of the soft type that does not crackle when handled. (I got mine from large-size candy bars.)

After the cement dries the foil will stick like an inner-tube patch, Fig. 1D; it can be smoothed out with the palm of the hand. You are now ready to connect the speaker and make a test. If the volume of the set is too great and the heavy notes

produce too much volume, it can be remedied by placing a 1 to 3 meg. resistor across the speaker terminals. This will prevent the speaker from a repeated disaster.

F. A. MERRICK

RCA Victor R50, R55. Set plays OK for 20 to 30 minutes, then slowly fades down. We must realize that condensers that have been in service for about two years or more often develop leakage although they may not break down and short.

We have been using a simple test circuit for condenser leakage test which has proven very satisfactory. See Fig. 2B. Naturally this is applied to paper-type condensers only. By applying test prods to the suspected condenser, after disconnecting condenser leads from the circuit, a full-scale deflection of the meter is obtained after which the meter hand returns to zero if there is no leakage in the condenser. Should a complete zero reading not be obtained a leakage of some extent is present.

By applying this test to condenser C34, Fig. 2A, a reading equal to the 30 V. position on the meter was the lowest obtained. Likewise a reading of 40 V. on C36.

These were replaced with external units and the set worked OK. We have used this test on condensers for some time with complete satisfaction and it is surprising the number of condensers which show quite some leakage, while at the same time voltage readings on the set are not affected.

The average "B" eliminator has adjustable voltage output so that you may control voltage for those condensers rated below 250 V. while at the same time 250 V. is high enough to test condensers rated at even higher voltages.

FRED R. WARD

RCA Victor R-27. A case of low volume in this A.C.-D.C. set was traced to the double 5 mf. electrolytic condenser bypassing the cathode bias resistor in the detector and output stages, as shown in Fig. 3. The condenser had decreased in capacity and when opened seemed to have dried out, possibly due to the heat from the heater series dropping resistor which is mounted in the chassis near the condenser. However, the same trouble was later found in a DeWald set of similar design having the resistor in the power cord. In this case the decrease in capacity had not been so great.

HAROLD L. KRAMER

"Sound" Experiences. This experience occurred while working as a sound projectionist.

A certain radio receiver gave very noisy reception. A Service Man who had made several unsuccessful attempts to locate the trouble, finally called me to take a look at the set. The customer complained that the volume in his locality seemed to vary so much that the parlor light would change noticeably, which led me to investigate the light he mentioned. It was of the pull chain type and when I pulled the chain I noticed that the set made more than the usual click; the sound continued for a couple seconds not as individual clicks but as a steady noise, accompanied by flickering of the light. Then everything would appear OK until a trolley car or truck went by when the crackling would again begin. A new socket, in the fixture, in place of the one with defective contacts remedied the condition, which was caused by radiation of energy from the arc thus formed.

Here is another experience. It was 1:30 p.m. and time to start the show. The arc light was burning; I started the machine, threw the picture on the screen—but no sound came forth! Hurriedly I looked around but could not see anything at fault. Occasionally, with the volume on the fader set quite high, a rasping sound would come, but no real music or talking. This was all traced to a poor contact on the grid prong of one of the sockets; the trouble arose, even though I had previously listened to a click from the stage speakers before starting time.

EINO A. KASARI

Stewart-Warner 950 and 100 Chassis. These sets have a tendency to oscillate badly and also tune broadly. After the usual methods, such as increasing the condenser capacity have been tried and soldered pigtails to the rotor shaft also have failed, remove the second R.F. 24 tube and substitute a 35 or 51. This will remove all oscillation and so sharpen up the tuning that it will be possible to bring in the Canadian station at 720 kc. without interference from WOR at 710 kc.

SMITTY RADIO AND ELECTRIC CO.

Model 35 Marconi. The complaint on this set was that it had a crackling noise, and a bubbling sound. Two weak 56 tubes were found and replaced. This did not correct the trouble, however. After turning the chassis over several times, oscillation started, and could not be stopped. It was found that one tuning condenser section had no direct ground lead, and repairing this defect, and also cleaning the rotor contacts cleared up the trouble.

Brunswick 14. Abrupt fading and return of signal was experienced with this set. Whenever the analyzer was plugged into a socket the set would perform perfectly, and all voltages appeared correct. Pulling out one of the 45-type push-pull tubes also would bring back its pep. After many continuity tests, the first A.F. transformer secondary was caught open-circuited. It had previously tested closed several times.

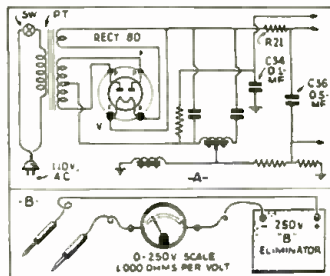

Above, Fig. 2. Trouble in an RCA R50, R55. Below, Fig. 3. RCA-Victor R27, a case of low volume.

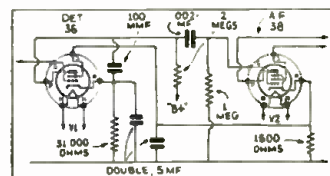

Fada 51C. The volume control of this set was very noisy. As new controls for these machines have to be ordered from the United States (they are not distributed in Canada now) the following method was used as a temporary repair.

Install a 5,000 ohm unit and insulate the shaft. Connect a 1,500 ohm fixed resistor in series with it and increase bypassing with a .25-mf. condenser. The best size is determined by experiment, choosing a size which will offset oscillation. The set thus repaired worked as well as new.

Lyric S7. The set was dead and the pentode output tube was red hot. The output transformer was open, which left no voltage on the plate and the screen-grid had to carry the full load.

DAVIS RADIO SERVICE,
Portage la Prairie, Manitoba

Atwater Kent Model 60. This set would play very well for a few moments and then cut out. Snapping the power switch off and on would usually bring the set back to operation, but it would always stop again. A continuity check on the speaker revealed an open voice coil. A careful inspection showed that one of the leads running along the speaker cone from the output transformer lug to the voice coil was spliced. Vibration had loosened this splice enough to cause a poor contact, and a little volume sufficed to cause it to cut out. A drop of solder remedied the matter.

U. S. Radio No. 8 Series Super. An annoying case of fading had developed and was traced to a defective .04-mf. coupling condenser between the plate of the type 27 second detector and the 47 output tube. A new condenser restored the set to full operation.

U. S. Radio Model 26-P. Except for a faint whisper from a local station, the set was dead. A check revealed a lack of screen-grid voltage on the 24 tubes in the R.F. stages, due to a shorted .4-mf. screen-grid

(Continued on page 616)

Fig. 1. A way to repair the Kylectron type of speaker used in Peerless sets.

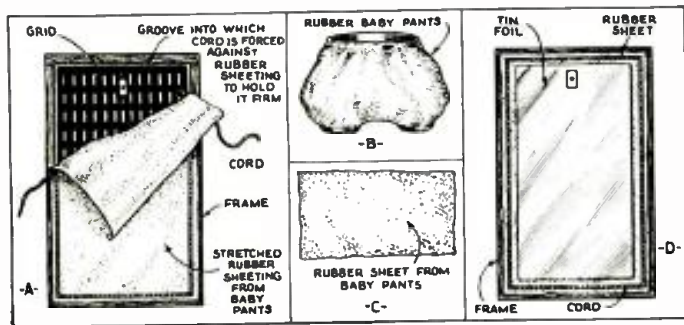

THE DESIGN OF MODERN TEST EQUIPMENT

A really comprehensive discussion of design problems relating to service instruments. Part I "covers" the meter.

SAMUEL C. MILBOURNE Part I

AS MOST electrical measuring devices are basically *current-measurers*, no matter what their scale may be, let us first take up a standard D'Arsonval 0-1 ma. meter and explain briefly its theory of operation.

In form of construction, such a meter consists of a permanent horseshoe magnet between the 2 poles of which is suspended an armature; attached to this is a pointer and a spring arrangement to hold the pointer to its zero position

when no current is being passed through the armature coil. When a current is passing through the armature coil, it becomes an electro-magnet, with two poles of opposite polarity, and the reaction between the energized coil and the permanent magnet causes the coil to rotate on its axis so as to facilitate the attraction of the unlike poles and the repulsion of the like poles of the two magnets.

The amount of the movement is de-



Fig. A. The meter—a current-indicating device.

termined by the balance attained between the resiliency of the spring mechanism and the strength of the magnetic field set up by the current flowing through the coil. Since the strength of the magnetic field set up around the coil is determined by the amount of current flowing (Continued on page 626)

Fig. 1. Circuits for indicating current and voltage, using the basic current meter and a simple vector diagram ($R=500$ ohms; $X_c=3,490$ ohms; $Z=3,590$ ohms).

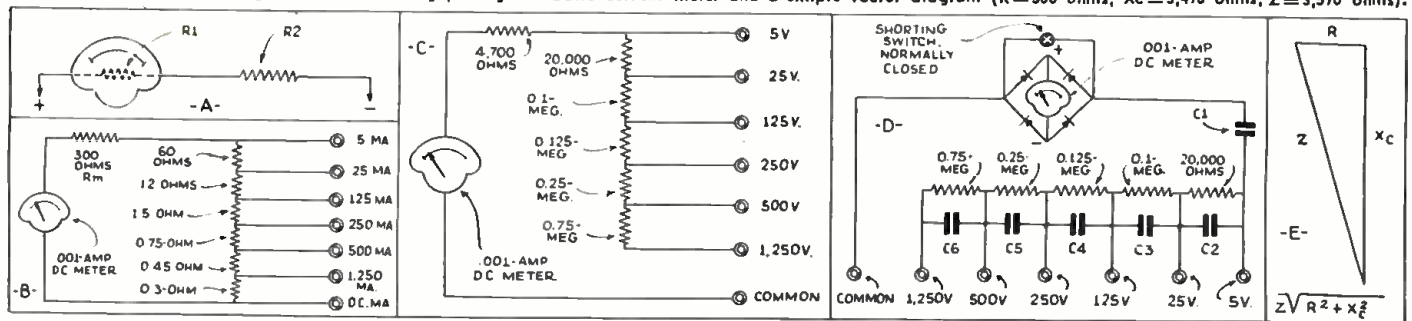

METAL TUBE "SHORT" AND "OPEN" TESTER

G. F. BENKELMAN

The use of a carefully planned network of resistors permits leakage and short tests on all metal tubes.

THE NEW octal-base tube socket lends itself to the design of a series-resistance type metal tube short tester. The only parts required are an octal-base tube socket, 4—500-ohm insulated resistors, 2—1,500-ohm insulated resistors, and 1—5,000-ohm insulated resistor.

In the circuit diagram, the terminals, as numbered in the resistor circuits, connect to the respective numbers in the tube-base diagram. The illustration shows the under-socket appearance of this arrangement with 1-W. insulated resistors connected to the socket terminals. The junction between the 2—1,500-ohm resistors is connected to a flexible lead to which must be attached a small grid-cap for tubes with top-cap connections. Terminals 3 and 8 have additional flexible leads for connection to an ohmmeter.

Practically all of the metal tubes have heater terminals in positions 2

and 7. As may be observed from the diagram, the heater filament of a tube would complete a circuit from terminal 3 to terminal 8 through the resistors. Neglecting the small resistance of the tube heater, the sum of the resistors in the circuit is 10,000 ohms. An ohmmeter connected to terminals 3 and 8 should indicate 10,000 ohms when a good tube is inserted in the socket. If the heater circuit of the tube is open, the reading will be above 10,000 ohms. If the heater circuit is intact and a leakage exists between elements of the tube, the reading on the ohmmeter will be less than 10,000 ohms—because that leakage would be in shunt with one or more of the resistors.

Defects, due to the mechanical displacements within a metal tube, usually form a low-resistance short which may be easily detected with this arrangement. As will be observed on the diagram, the (Continued on page 627)

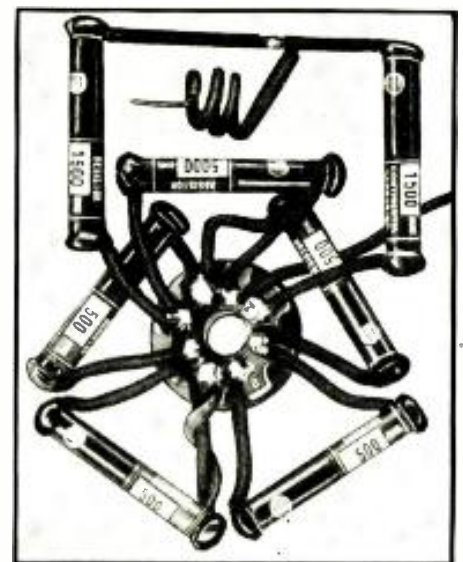
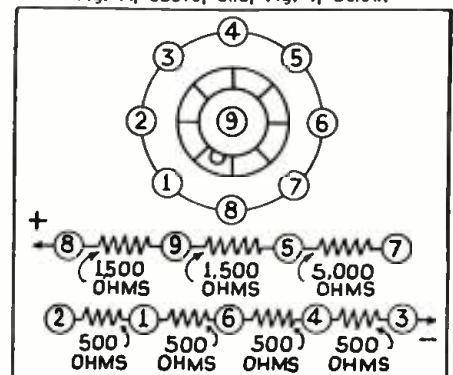

Fig. A, above; and, Fig. 1, below.



AN AUTOMATIC ELECTRONIC POTENTIOMETER

An electronic instrument which has many applications in controlling electric devices.

AN AUTOMATIC potentiometer in which the balancing circuit is continuously and rapidly adjusted by photoelectric control has just been announced. The instrument provides a highly sensitive means for indicating or recording voltage or current at ranges as low as 2 millivolts or 5 microamperes full-scale, or even lower if required. Temperature or other physical quantities convertible to electrical terms may

Circuit showing the PE. cells and mirror galvanometer with a vacuum tube amplifier.

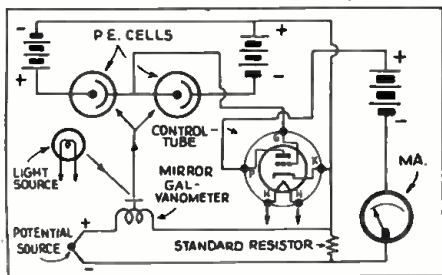

The exterior and interior views of the electronic potentiometer which is photoelectrically operated in a special bridge circuit.

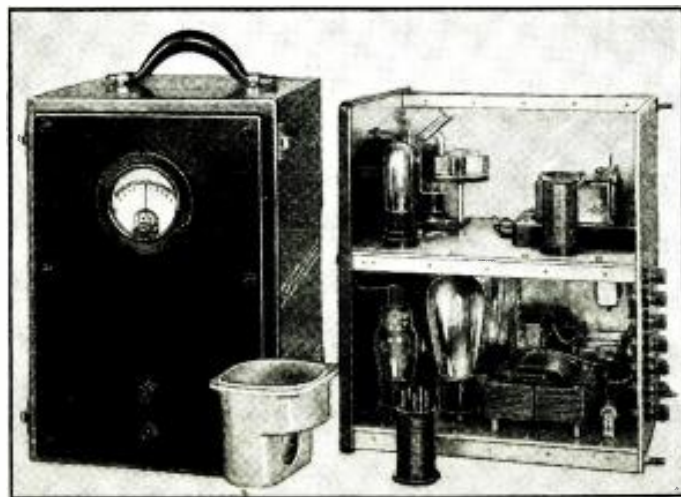

be indicated, recorded or controlled with a speed and precision hitherto unattainable in dealing with the minute electrical input encountered in many such applications.

The instrument furnishes an indicating current capable of operating a number of meters, recorders, control relays, etc., which can be placed at any distance from the potentiometer proper.

The instrument contains no moving parts with the exception of the galvanometer itself, which has no control torque and is free of zero drift. Deflection of this mirror galvanometer causes a beam of light to differentially illuminate a pair of photo-tubes. These photo-tubes are in a bridge circuit con-

nected to the grid and cathode of a vacuum tube, so arranged that the changing light "differential" between the photo-tubes results in a change of grid voltage. This change in grid voltage, in turn, electronically readjusts the indicating current to balance the circuit across the standard resistor. The circuit will hold itself constantly in balance, and immediately readjust itself for any change of input value. Balance involving a full-scale change in indicator deflection takes place in a fraction of a second.

This system of balancing is independent of elements other than the value of the standard resistor and the meter giving (Continued on page 615)



Fig. 1. The 2 circuits used in the tests described. Circuit A is used in obtaining the curve A in Fig. 2, below. Curves B, C and D were derived from circuit B

DISTORTION IN RESISTANCE-COUPLED AMPLIFIERS

VIRGIL M. GRAHAM

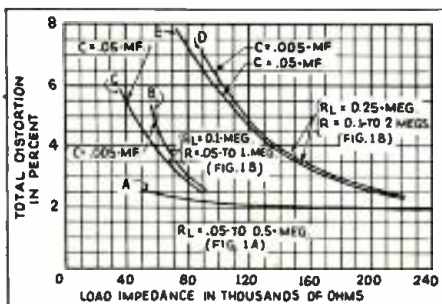
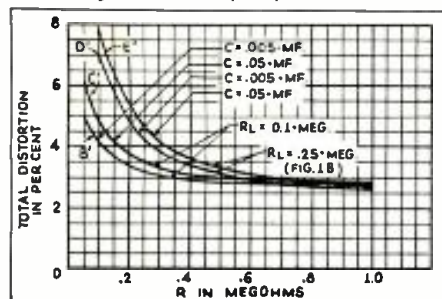

Fig. 2. Total distortion as a function of load impedance for varying resistance and capacity.

Fig. 3. Total distortion as a function of R for varying values of capacity and load.



IN THE consideration of distortion in a radio receiver there is one source that the designer is liable to overlook even though he is thoroughly cognizant of the technical facts. It is the coupling of a high-gain A.F. amplifier to the succeeding tube. The correct values of load resistor, coupling condenser, and grid resistor of the following tube are important as regards harmonic production, as well as frequency range and other limiting factors. In the design of higher-fidelity receivers any source of distortion becomes important, even though it is not great in magnitude.

The purpose of this article is to present some quantitative data on the results of changing the relative sizes of the plate and grid resistors and coupling condenser in such a network.

For the quantitative investigation, the data used for the accompanying graphs were obtained with the circuits shown in Figs. 1A and 1B.

Much data of academic interest could be shown but it was deemed better to present data which should be more useful for practical application requiring a

minimum of calculation.

Accordingly, Fig. 2 shows 5 curves of total distortion as follows:

TABLE I

Curve	Circuit	RL	C	R
A	Fig. 1A	.05 to .5-Meg.		
B	Fig. 1B	0.1 Meg.	.005 mf.	.05 to 1 Meg.
C	Fig. 1B	0.1 Meg.	.05 mf.	.05 to 1 Meg.
D	Fig. 1B	.25 Meg.	.005 mf.	0.1 to 2 Meg.
E	Fig. 1B	.25 Meg.	.05 mf.	0.1 to 2 Meg.

Data for curves was taken with the triode section of a type 6Q7 tube operating as follows:

$$E_b = 250V., \quad E_{g2} \text{ (on grid)} = 0.5 V. \text{ r.m.s.}$$

$$E_c = 2.5 V., \quad E_f = 6.3 V.$$

It will be noted that the last 4 curves are plotted against the load impedance values resulting from RL, C and R. Curve A shows the effects of reducing the load and thus working on dynamic characteristics of greater and greater curvature. Curves B, C, D, and E, therefore, show the increase of distortion due to the introduction of the reactive components of the networks indicated. The effect of a change of 10 to 1 in the capacity value of the coupling condenser (Continued on page 619)

THE VERSATILE CATHODE-RAY TUBE

After a brief introductory summary of cathode-ray theory, the author discusses several new and interesting applications of cathode-ray equipment. The article concludes with a very interesting "open forum" on cathode-ray terminology.

R. D. WASHBURNE



Fig. C. This "analyzer" segregates and records every component in a given sound.

OSCILLOLOGY—a pretty-sounding word, and one that stimulates the imagination to conjure all manner of attributes for its basic component—the cathode-ray tube.

Strange as it may seem, there is hardly a conceivable application of the cathode-ray tube, which cathode-ray equipment either is now performing, or is in a fair way to accomplish in a short time. The "tree" of oscillogy, Fig. A, testifies to the amazing scope of this rapidly-growing field.

Without going too much into detail, let us take just a moment to define a few terms. *Oscillogy* is the study of cathode-ray technique; its instrumentalities are the *oscilloscope* and the *oscillograph*, and their associated components (oscillators of various types, and their respective power supply systems). (The electromechanical modus operandi, now seldom used outside the laboratory, could be included by slight changes in the above definition of oscillogy.)

Preceding issues of *Radio-Craft* have discussed these details at length.

WHAT ARE CATHODE RAYS?

Cathode rays, be it recalled, are the electrons that are radiated by certain substances when these substances (ordinarily oxides, and usually heated by a filament) are (a) placed inside an evacuated envelope; (b) then, connected to the negative (cathode) terminal of a suitable voltage supply; and, finally, (c) the positive (anode) terminal of this voltage connected to an electrode (the anode electrode) inside the same evacuated envelope. The electrons then pass in a steady stream from the cathode to the anode.

These cathode rays in themselves are invisible, but they may be caused to manifest their presence by having interposed in their path a substance (usually, *willemite*, pasted onto the inside, domed end of the vacuum tube) that glows or *fluoresces* when the ray-electrons strike or impinge upon it.

So much for the actual cathode-ray tube, the preceding generalities concerning which, date back to the middle of the 19th century. Even the oscilloscope and oscil-



Fig. B. Lily Pons "sees" her high C.



Fig. D, above. This "pre-recording" oscillograph supplies "before," "during," and "after" data. Fig. A, left. "Tree" of the ray-tube field. Space limitations preclude a more detailed break-down. Fig. F, below. the flaw-testing of razor-blade steel.

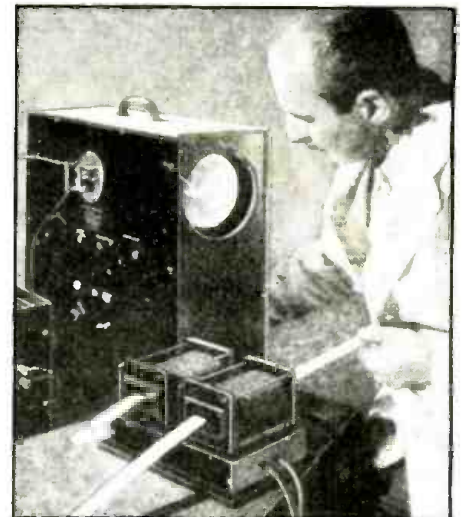
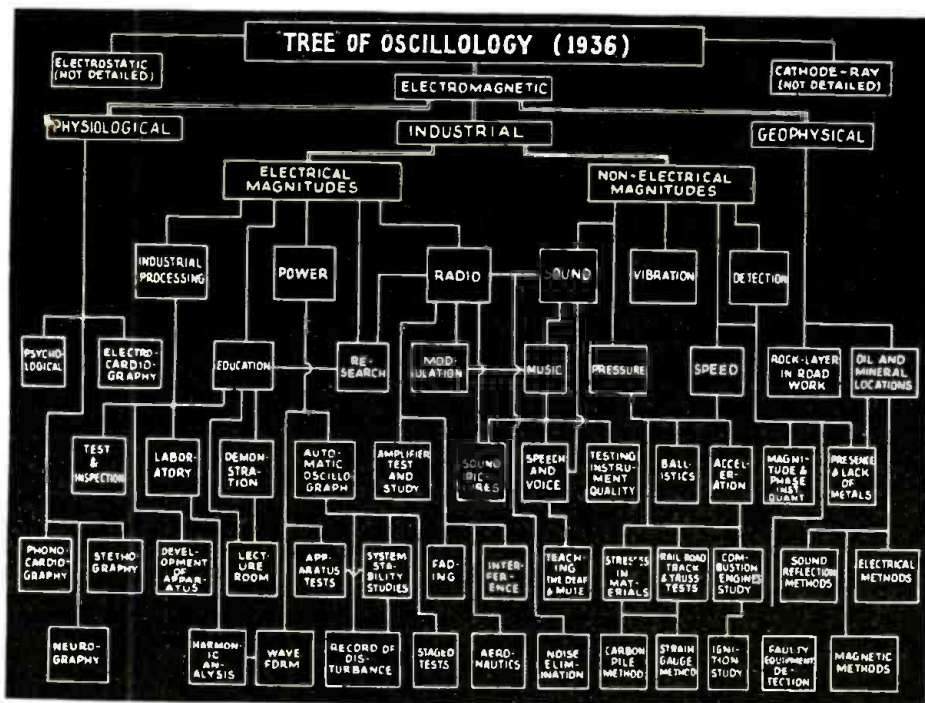



Fig. A. External appearance of the new unit.

MODERNIZING THE SET ANALYZER

A free-point selective system using 2 meters from an old analyzer to produce a modern, flexible, servicing unit.

R. P. HILTNER

WITH THE advent of multi-element type tubes and complicated circuits embodying these tubes, the old reliable set analyzer is no longer able to cope with the requirements necessary for making a complete set analysis.

With the above thought in mind, a plan was devised for modernizing obsolete set analyzers into a 2-meter analyzer employing the meters of the old analyzer, namely, (1) an A.C. meter, the initial range of which must be 0-4 V. or less, and (2) a D.C. meter having a sensitivity of 1 ma. or less, (1,000 ohms-per-volt).

The method used for circuit analyses is known as the "master rotary-free-point selective system" and makes use of 4 positive-action rotary switches per-

mitting speedy voltage, resistance and current measurements to be made at all socket pin positions; and, for external tests, makes possible the use of only 2 polarized pin-jacks for all ranges without the necessity of removing and re-inserting test leads.

Referring to the schematic circuit diagram (as drawn from an original by G. Salerno), it is noted that the 9-wire analyzer cable connections are wired parallel with the contacts of the "NEGATIVE SELECTOR," the "POSITIVE SELECTOR" and pin positions of the individual 4, 5, 6, combination 7, and octal-base type sockets located on the analyzer panel.

This circuit arrangement is the nucleus of free-point analysis insofar as it enables any 2-socket pin positions to be analyzed merely by rotating the "POSITIVE" and "NEGATIVE" selectors to the desired positions. In other words, these 2 selectors can be characterized as 2 "automatic" test prods.

Direct-current measurement for any element of a tube is obtained through the use of the "CURRENT SWITCH." This switch is of the 2-deck rotary type and is unique in design in that it opens circuits which normally are closed, and inserts the milliammeter into the various cable leads of the analyzer plug, as shown in the schematic diagram.

(Continued on page 620)

Fig. B. The back of the panel, showing parts. Note symmetrical arrangement of the components.

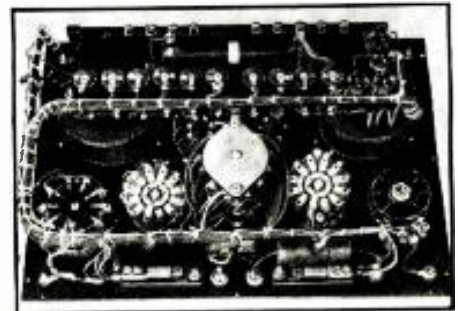

REQUIREMENTS IN SERVICING 16MM. TALKIES

J. J. BRESSLER

Some of the requirements for servicing home talkie equipment for the Service Man.

THE DAY is rapidly approaching when the alert and live-wire radio dealer and Service Man will have to know something about sound-on-film, especially such devices as 16 mm. "home talkie" equipment.

With quantity production placing 16 mm. sound-on-film projectors in a popular class within reach of the general public, the question arises—who will merchandise this type of equipment?

The fact that amplification circuits, radio tubes and reproducers are an integral part of these units, makes it seem more than likely that radio or electrical stores are the most logical organizations to handle them, both from the standpoint of knowledge and of repair service.

So far, it seems that the dealer and Service Man are either indifferent or entirely unaware of this rapidly growing source of potential income; growing, so to speak, in their own front yards.

radio receivers, and certainly far easier to understand for trouble shooting.

It is the writer's contention that once the radio service and dealer groups get the "hang" of the 16 mm. field, they will automatically become potential service depots for the local theatres, another source of lucrative profit.

The exhibitors and theatre owners themselves are not only willing to accept you, Mr. Dealer and Mr. Service Man, but anxious to, IF they can be sure that they will receive the proper service, which at the present is available only from the larger companies.

The difference lies in time. As a rule the exhibitor has to wait for an out-of-town trouble shooter, whereas a local man, if immediately available, would be called without hesitation, because it means many dollars lost for every minute the house is dark.

Some of the points of which the (Continued on page 621)

SIMPLICITY OF "TALKIES" SERVICE

The sound section of a movie projector is really less complicated than the "noise suppression" and "automatic volume control" circuits in the run of current superheterodyne

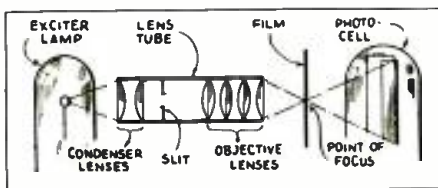
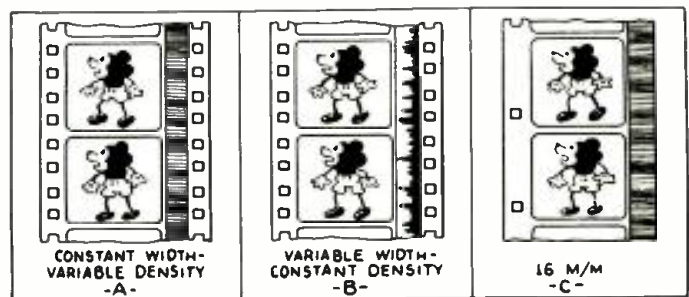

Fig. 1, left. The light path from exciter lamp to PE. cell.

Fig. 2, right. The differences between the two types of recording, and width of film.



FIRST PRIZE \$10.00
 SECOND PRIZE 5.00
 THIRD PRIZE 5.00
 Honorable Mention

EXPERIMENTERS: Three cash prizes will be awarded for time- and money-saving ideas. Honorable mention will be given for all other published items. Send in your best "kinks"!

SHORT-CUTS IN RADIO

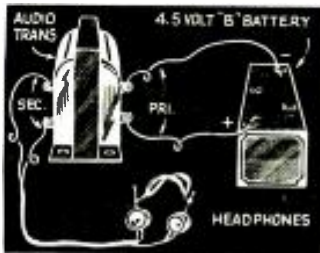

Fig. 1. Testing transformers.

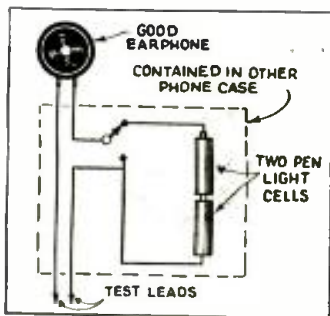

Fig. 2. Handy testing unit.

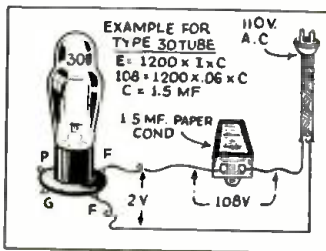

Fig. 3. A novel filament supply.

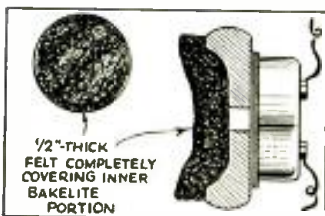

Fig. 4. Comfortable earphones.

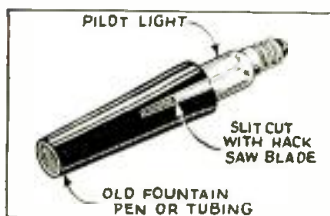
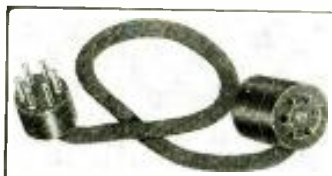

Fig. 5. Above, lamp remover.

Fig. 6. Below, an extension socket.



FIRST PRIZE—\$10.00

TESTING TRANSFORMERS. One of the most frequent causes of noisy or scratchy reception in receivers is a defective winding of an A.F. transformer. It is very difficult to test for such a condition, since the winding is not actually open. A 4.5 V. battery may be connected across either winding of a suspected transformer, and a pair of phones across the other winding. If the transformer is faulty, a loud scratching sound will develop in a few minutes. In case no noise shows up, reverse the phones and battery, connecting each where the other previously was, so as to test both windings.

GEORGE H. NAKAS,
Honolulu, Hawaii.

SECOND PRIZE—\$5.00

TESTING UNIT. One of the phones in a headset that I use for test purposes burned out. Since only one phone is needed for test work, the arrangement shown in Fig. 2 was devised. The headset was an old Baldwin make and the 2 penlight cells together with the small toggle switch just fit in the case of the burned-out unit. By throwing the switch to the proper position, the headset may be used either for continuity tests, or simply as a receiver for audio testing.

IVAN S. GRAHAM

THIRD PRIZE—\$5.00

FILAMENT SUPPLY. Often times the proper size resistor is not handy for reducing the line voltage to the correct value. When the power supply is A.C., the scheme pictured in Fig. 3 may be used with fine results. The formula for finding the size of the condenser is: E (volts) $\div 1,200 \times I$ (amperes) $\times C$ (capacity in mf.). For example, in the case illustrated, $108 = 1,200 \times .06 \times C$, which works out to C equals 1.5 mf. Good-quality paper condensers must be used, but the voltage rating need not be very high, a condenser of about 200 V. rating being sufficient for use on a line up to 125 V. The condenser acts just as the more ordinary resistor to drop the voltage to the required value for the tube.

P. MORTZ

HONORABLE MENTION

PHONE CUSHIONS. Those who wear headphones for long periods of time will appreciate the suggestion pictured in Fig. 4. The cushions are

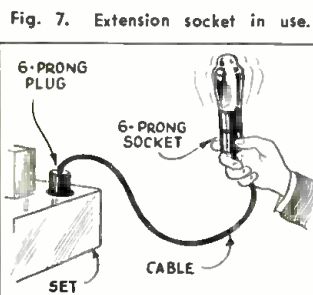

Fig. 7. Extension socket in use.

made of pieces of any thick, soft fabric, as heavy felt. They should be cut out large enough to completely cover the earpiece of the receiver. The material should be at least 1/2-in. thick and is cut in a circular shape to conform to the earpiece. No hole is cut for the center, however, the discs of felt being left intact. They are then glued in place.

The result will be a very comfortable fit, and in addition, the tone will be found rich, and "easy" on the ears; cheap headphones will lose the "tinny" sound they often have.

GRIFFITH SECHLER

HONORABLE MENTION

REPLACING DIAL LAMPS. Most set builders and Service Men have had trouble in removing or replacing a dial lamp in certain sets. A handy tool for this purpose may be made from the rubber barrel of a discarded fountain pen or from a piece of hard-rubber tubing. See Fig. 5. A slit is made in one side with a hacksaw. The dial lamp will be found to fit snugly in the tubing, as the split permits a slight amount of spring to the ends; this holds the bulb firmly, but allows the tube to be removed easily when a bulb has been put in place.

HAROLD MADEEN

HONORABLE MENTION

TUBE TESTING KINK. The unit shown in Fig. 6 has been found of use when testing automobile radio sets which have tubes placed bottom-side up. Often such a set will be found to test well when on the service bench where the tubes are right side up, but when installed in the car, poor results are had! The extension socket is simply a short length of cable of the required number of wires, with a socket on one end and a tube base on the other. The corresponding prongs of each are connected together. Several of these may be made for different numbers of prongs, since the cost is very low. Another use is to shake a tube while it is in operation, as in Fig. 7, thus showing if it is shorted.

JOHN MEDNANSKY

HONORABLE MENTION

TWEETER SPEAKER. A reproducer of this type may be made from an auto horn of the air type. These units have a tapering throat

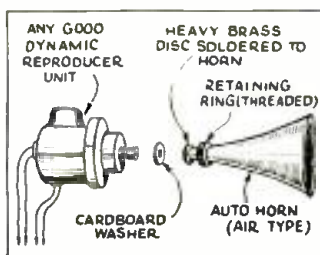

Fig. 8. A homemade tweeter.

of a size which can easily be adapted to a speaker unit. A heavy brass disc is soldered to the small end, as shown in Fig. 8, and a cardboard or fibre washer is used between the disc and the speaker unit. The horn should be between 10 and 15 ins. long, and the speaker unit may be of any good make. Be sure to slip the retaining ring onto the small horn end before soldering on the disc.

JOE YEAGER

HONORABLE MENTION

WINDING KINK. When winding long single-layer coils, it will be found helpful to place a small piece of paper under each 10th turn as depicted in Fig. 9. This will allow easy counting of turns, and is much easier

(Continued on page 618)

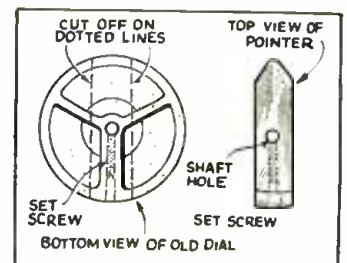

Fig. 12. Inexpensive bar knobs.

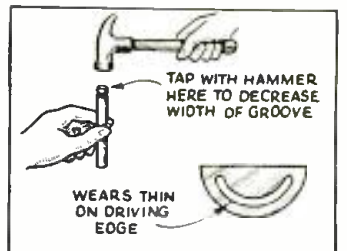

Fig. 11. Vernier drive repair.

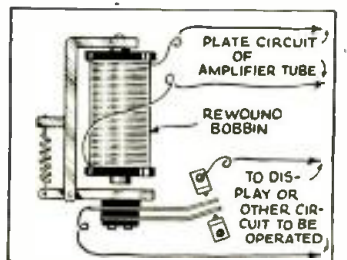

Fig. 10, above. Sensitive relay.

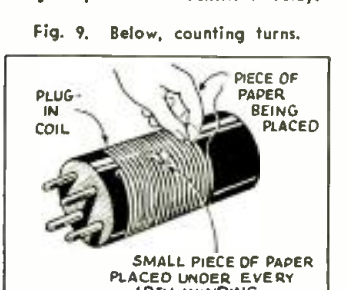
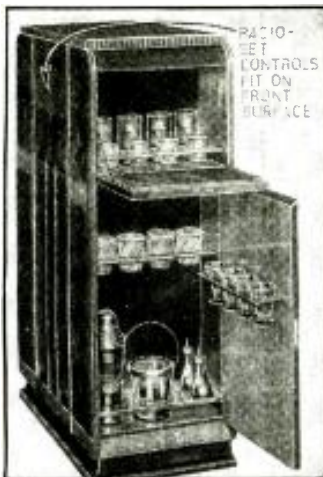

Fig. 9. Below, counting turns.

THE LATEST RADIO EQUIPMENT



Radio set and liquor bar. (944)



Comprehensive tube tester. (945)

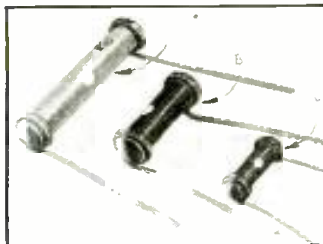

New carbon resistors. (946)



Above, Deluxe analyzer. (947)
Below, new permanent-magnet dynamic. (948)

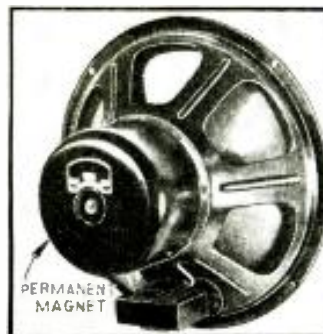

PERMANENT MAGNET

MUSIC WHILE YOU DRINK! (944)

THE CABINET shown is so constructed that any of several different makes of receivers may be easily installed. Ample space is provided for installation of a large chassis and loudspeaker. The outside dimensions are 44x28x-15½ ins. deep. The cabinet work and wood used are of the best.

TUBE CHECKER (945)

EXCEPTIONAL versatility is featured in this tube checker. The heater voltage may be applied to any 2 prongs, by the use of selector switches. Leakage between any 2 elements is tested with the cathode hot, the indicator being a sensitive neon bulb. Any leakage of over 0.5-meg. shows brilliantly; the leakage may be measured on the meter if desired. An index number system is used, and over 100 popular tubes are arranged on a chart for quick reference. A large number of odd tubes are arranged in the same way on another chart.

NEW CARBON RESISTORS (946)

(Aerovox Corp.)

A SPECIAL moulded body that is non-hygroscopic is used on these new resistors. They are said to be absolutely noiseless on or off load, and are non-inductive with no appreciable resistance change at high frequencies. All ratings are based on R.M.A. standards and the units are color coded. They are available in ratings of ½ (C), ¼ (B), and 1 (A) W., and resistances of 100 ohms to 10 megohms.

DELUXE ANALYZER (947)

(Supreme Instruments Corp.)

IT IS claimed that this is the most complete (yet simple) analyzer ever designed. The meter

Modern-design ribbon mike. (949)

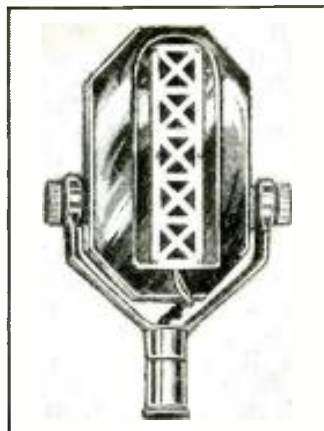

Renewable fuse. (950)

is of the long-scale, 5 in. fan type. All types of tubes may be tested, a built-in power supply being furnished. Ranges: D.C. ma., 5, 25, 125, 250, 500, 1,250; A.C. and D.C. volts 5, 25, 125, 250, 500, 1,250, all 1,000 ohms-per-volt. Capacity ranges: .05, .25, 1.25, 2.5, 5, 12.5; resistance, 2,000, 20,000 ohms, 0.2-meg., 2, 20 megohms. The instrument rectifier is protected against overload. The free-reference-point system of set analysis is used. All equipment is housed in an oak case with detachable cover.

PERMANENT-MAGNET REPRODUCER (948)

A LINE of permanent-magnet dynamic speakers is now offered, which includes sizes of 6, 8, 10, and 12 in. units. The latter is illustrated. These highly efficient speakers are made possible by use of the new alloy—alnico, which enables results to be obtained that are equivalent to those of the electromagnetic field type, now in general use! The new speakers are more compact and lighter than the older type, which eliminate two of the disadvantages of this type reproducer.

NEWEST RIBBON MICROPHONE (949)

(Universal Microphone Co.)

COMPACTNESS is a feature of this new unit, as it measures only 2¼ x 4¼ x 1½ in. thick. The weight is 1½ lbs. It is designed for all types of operation including broadcast, P.A. work, and amateur activities. Case is hinged, and swivels to the required angle. It is furnished complete with plugs.

(Continued on page 642)



Newest in light-sensitive cells. (951)



Frequency modulator unit. (952)



Electrolytic condenser. (953)

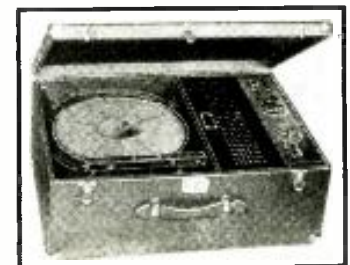

Portable P.A. outfit. (954)

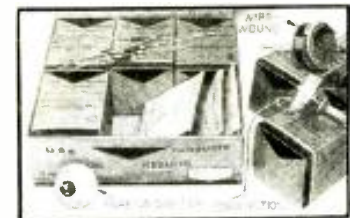

Above, volume control kit. (955)
Below, safety fuse puller. (956)

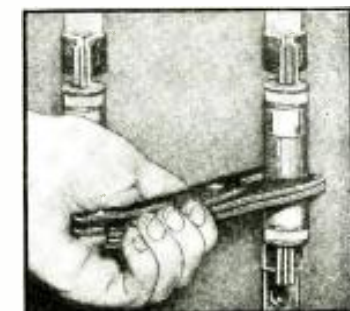

Name and address of any manufacturer will be sent on receipt of a self-addressed, stamped envelope. Kindly give (number) in above description of device.

LOW-PRICED SERVICE OSCILLATOR (962)

(Triplett Elec. Inst. Co.)

HERE IS a self-contained signal generator which covers the range from 100 to 30,000 kc. (all on fundamentals), in 6 bands. An extra-long 12-in. direct-reading vernier scale is used which enables the user to set the instrument with great accuracy. Perfect attenuation on all bands is a feature. A separate A.F. oscillator supplies a 400-cycle signal which may be used when desired. The case is of dull black finished hardwood, and measures $7\frac{1}{2} \times 6\frac{1}{2} \times 4\frac{1}{2}$ ins. deep. (This case matches other test equipment, so that all may be fitted together in one box.) The necessary batteries are contained in the case. An A.C. model with the same features is available at the same price for those who desire that type instrument. Also, the battery-operated unit (circuit is shown) may be had without the A.F. oscillator.

NEWEST IN OSCILLOSCOPES (963)

(Triumph Mfg. Co.)

A NEW idea in oscilloscope construction is shown. The controls are mounted on the top of the cabinet, while the tube itself is mounted at an angle so that it may be viewed from almost any position. It is also better protected than it would be in the usual position. Every control of the instrument is designed for ease of operation, and the more important controls are arranged at the front of the deck. A special lock-in circuit is used to prevent the image from drifting. The sweep circuit has a range of 20 cycles to 50,000 kc., and has a calibrated switch and a vernier control. A self-contained synchronizing sweep may be switched on without the use of any other apparatus, to show the power line waveform.

Both horizontal and vertical axes have amplifiers of about 37 gain. The deflection sensitivity is 2 V. peak per in. or 0.7-r.m.s. V. per in. Without the amplifiers, the sensitivity is 75 V. peak or 27 V. r.m.s. per in.

The entire instrument is of very rugged construction, and is well able to stand continued use in laboratory or any industrial application. All tubes may be easily reached by simply removing the metal hood. The tubes used are: 1-906, 1-879, 1-885, 1-80, 2-6C6s.

The input impedance when using the amplifiers is 0.5-mek.; the

value when feeding directly to the plates is 1 mek. Blocking condensers are built into the instrument to cut off any D.C. which would otherwise enter.

The apparatus is ideal for use in taking photographs of waveforms, due to the perfected lock-in system, and the linearity of patterns. Return-trace has been eliminated, except at the highest frequencies.

A calibrated scale may be attached to the escutcheon plate of the 906 tube for use in examination of waveforms and resonance curves.

A safety switch opens the 110 V. primary circuit, so that it is impossible to open the case without entirely cutting off the power.

The physical dimensions are, $12\frac{1}{2} \times 18\frac{1}{2} \times 8\frac{3}{4}$ ins. wide. The total weight is 21½ lbs.

INPUT ROBOT TUNER (964)

(Radolek Co.)

THE "HEART" of the R.F. system of several new radio receivers made by this company is a "radio robot." All the circuits of the R.F. system are contained in this unit, including oscillator and R.F. coils, band switch, padding and aligning condensers, and the combined oscillator—1st-detector tube.

The use of this unit is said to provide for much better reception, and to make the receiver much easier to service. The multi-coil system provides a separate set of coils for each band.

The circuit of the unit as it is attached to a receiver, and its actual appearance, are depicted. The robot is first aligned when made, then it is again aligned after assembly in the receiver, assuring peak performance under all conditions.

NEON-TYPE OUTPUT INDICATOR (965)

(Zephyr Radio Co.)

THE USE of an "output indicator" is an absolute necessity in these days of multi-band super-heterodyne receivers. Most types of such equipment are so very expensive that in the past many Service Men have had to do without them.

The apparatus here shown, however, is low-priced and very reliable. A long-life (about 1,000 hours, in the usual, intermittent service), low-price neon tube is employed. This type of indicator is very sensitive.

The transformer is so designed that the indicator may be connected directly across the voice

coil of a speaker, no adapters being needed. Due to the high step-up ratio of the transformer, a potential of less than 1½ V. is necessary to bring the tube to full brilliancy, once it has been set. One plate of the tube takes a slightly higher voltage to light than the other; when ready for the final adjustment of a receiver, the potentiometer is so set that only 1 plate lights. Careful adjustment of the receiver then will increase the voltage sufficiently to light the other plate, and an extremely accurate adjustment may be so obtained.

The case is of steel, finished in dull black, and measures 2x-3x5 ins.

VACUUM-TYPE POWER RELAY (966)

THIS relay is designed for 3 main uses, (1) protection against fire and explosion hazards, (2) remote control of high voltages, and currents, and (3) repeated contacting with elimination of pitted joints. Radio men working with all manner of special control units will be glad to know that a switch of this type is available. It is a S.P.S.T. switch and may be had in either normal-open or normal-closed contacts.

The switch, as shown in the detail illustration, is operated by means of a solenoid, C (equipped with heavy leads, A), which moves the contacts within the vacuum-sealed chamber. The vacuum chamber, D, is of hard glass which, in turn, is enclosed in a metal container, B, filled with sealing compound, F. The contacting elements consist of a plunger, E, of extremely high heat resisting metal, which moves into or out of 2 pools of mercury, G, terminating in leads H.

The switches are designed for operation at 110 V. A.C. at 20 A., or 65 V. D.C. at 20 A. Maximum rating is 2 kva. Speeds up to 100 contacts per minute at full load are possible, while at decreased loads up to 400 contacts per minute may be made. The control coil operates on 110 V., .015-A. A.C. The mechanical size is 5½ ins. long by 1½ ins. dia.

CRYSTAL-CONTROLLED CALIBRATOR (967)

(RCA Manufacturing Co.)

ACCURACY of 2 parts in a million is guaranteed for the calibration of this inexpensive unit. It has 2 fixed frequencies of 100 kc. and 1,000 kc., with a switch for selection; these two frequencies, and their harmonics, may be integrated to secure accurate

(Continued on page 631)

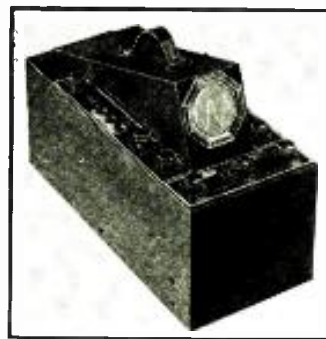

New oscilloscope design. (963)

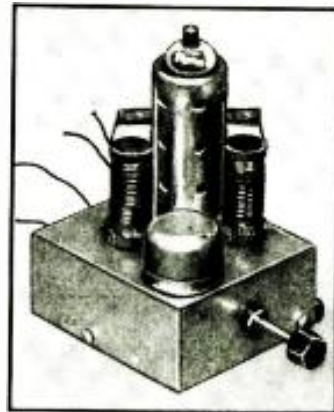

Above, and below, a separately-built "radio robot" receiver-input unit (964)

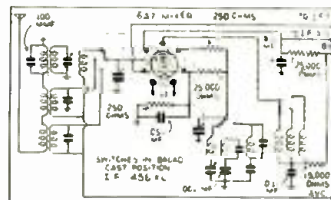

Above, and below, commercial-type neon output indicator. (965)

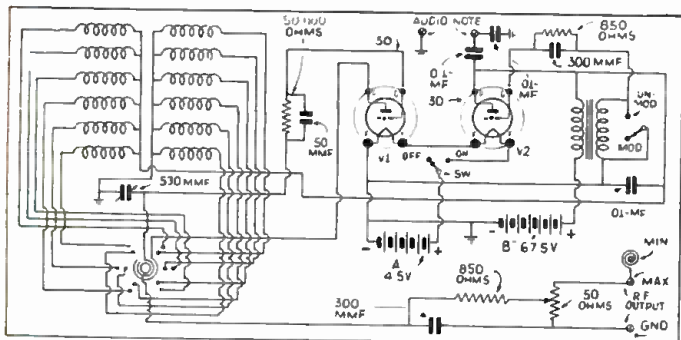
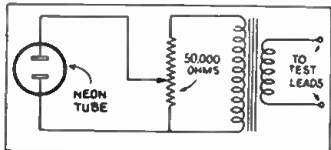

Left, and below, new service-oscillator circuit. (962)

Right, latest in power relays. (966)

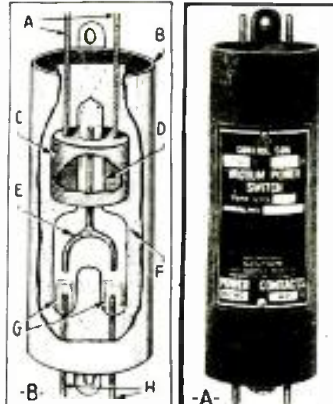

CORNERSTONES OF RADIO —THE BRIDGE

In this, Part II, the author describes, in an easily-understood manner, a subject which has stumped many radio experimenters—the Wheatstone Bridge and its uses.

E. W. SLOPE

PART II

FEW radio men immediately recognize a fundamentally-direct relation between the mechanical scales of the apothecary, and *electrical balance* as it exists in a radio circuit. Nevertheless there lies underneath the deceptive veneer of appearances a primal bond that, once discussed in terms of the former, will make clear as A-B-C the functioning of the latter; let us continue, then, our searching analysis (in 3 parts—Ohm's Law, the Bridge, and Phase—of which this is Part II) of radio fundamentals for the beginner.

Since we measure electrical power not in *mechanical* units, such as the *ounce* or *grain*, but by means of *electrical* units, we cannot expect to find in a radio set an exact replica of a drugstore balance. But despite the fact that an "electrical balance" looks quite different from the "mechanical balance" (or scales) of commerce, when we speak about "stabilized" circuits, and "neutralized" stages the truth is that *we are referring to something which has its actual roots in the balance principle* (though, this relation may not be instantly recognizable)!

In former times when electrical engineers in discussing electricity and its applications spoke about devices called "balances," the actual relation between these two kinds (mechanical and electrical) of balances was then more impressively indicated than today, when these *electrical balances* are called "BRIDGES."

If we wish to understand the principle of the *electrical bridge* we immediately must discard the conception of the word "bridge" as defined in the following description: "A *bridge* is a struc-

ture carrying a road or path across a stream, ravine, road, etc." In fact, and although there are of course good reasons why the engineer calls an "electrical balance" a "bridge," let us forget for a time even the electrical expression "bridge"; instead, let us stick to the term "balance."

THE COMMERCIAL BALANCE

Figure 4A shows the commercial balance which has been a very familiar device to everyone since the early days of childhood. From either side of the lever we observe 2 plates suspended, and exactly in the center of the lever there is a "zero indicator." Objects to be weighed are placed in plate No. 1, at one side, and pieces of calibrated metal each representing a certain weight are placed in plate No. 2 on the opposite side. Some of these small metal pieces are then added or taken away until a "balance" is obtained, or until the indicator in the center of the balance rests in front of the zero mark.

The commercial balance is of course very simple to understand. But let us now substitute for these common, everyday objects *electrical*—"objects" (or units)—i.e., *volts*, *amperes* and *ohms*. If we should now try to balance out an unknown number of ohms, against a calibrated number of ohms, by means of a balance as described above trouble would surely occur. The reason why we would not succeed is simple! *We cannot balance out purely electrical power by means of a mechanical device.*

Since *electrical* "objects" are entirely different from ordinary (mechanical) objects we have (Continued on page 634)

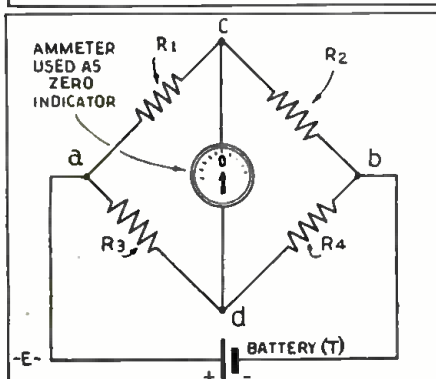
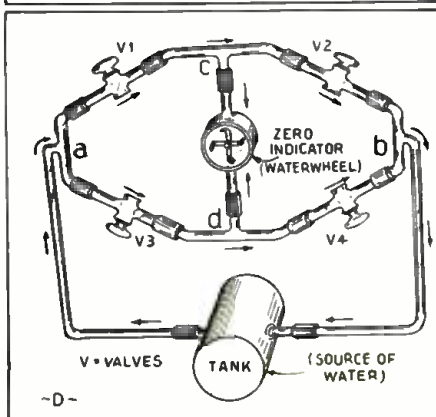
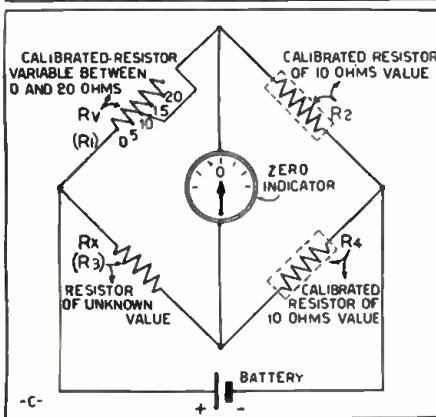
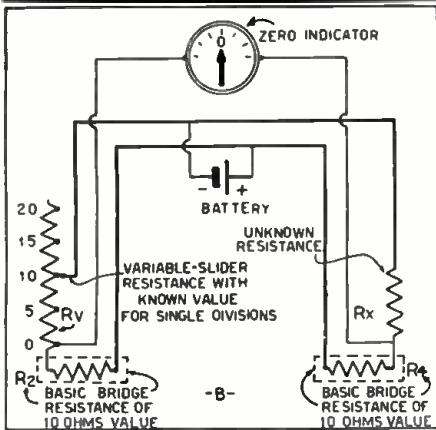
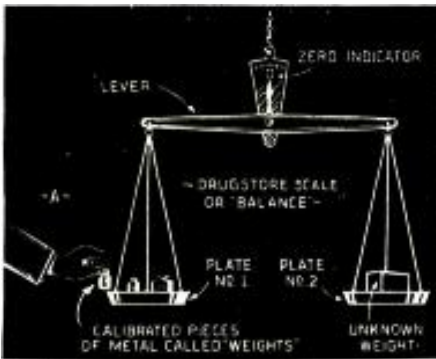
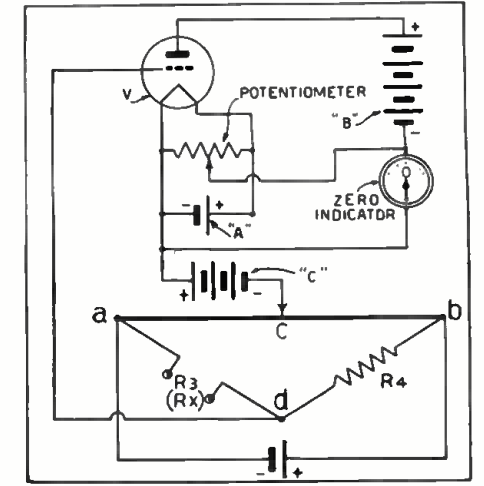
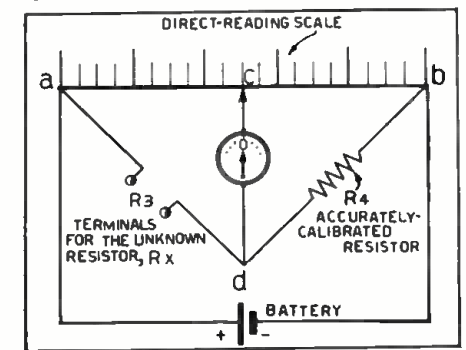

Fig. 4, left. Circuits A to E, inclusive, illustrate important fundamental principles of bridge operation that the radio beginner must master.

Fig. 6, right. This circuit introduces use of a vacuum tube, V, for increasing bridge sensitivity.

Fig. 5, below. Slide-wire a-b-c shows value of Rx.



HOW TO MAKE A BEGINNER'S 2-TUBE PORTABLE

Here is a battery set that just suits the beginner. It is easy to build, efficient and can be carried in a coat pocket. It compares favorably with sets using several more tubes.

J. T. BERNSELY



DESPITE the rather crowded and complicated appearance of the 2-tube receiver shown in the illustrations on this page, the beginner will find this set very easy to build; a fact which will be more evident by reference to the pictorial diagram. Whether or not it is a desirable type of set depends upon whether the constructor has a need for a radio set having the following characteristics:

This midget set will fit in the average overcoat pocket; reception is of the headphone type—but with sufficient volume to make the received programs enjoyable; the receiver requires no lengthy antenna for pick-up, but will enable reception from a considerable number of broadcast stations simply by connecting the antenna lead from the set to any convenient mass of metal (or ground); the "A" cells are self-contained (2 flashlight batteries) and the "B" battery is a 90 V. block which will fit in the other pocket of the coat; battery consumption is at a minimum, due to the use of 2 V. tubes; covers the complete broadcast band, as well as some of the police calls slightly below 200 meters.

As may be seen from the photo-

graphs, the mechanical construction is professional in appearance and calls for some mechanical skill and ingenuity in building this receiver. If the layout and wiring are followed carefully, and the type of parts employed in this model are duplicated, then no trouble in either building the set or making it work properly need be anticipated. But, *please*—do not write the author if you should fail to get the anticipated results, until you have carefully checked all the connections; and the electrical values and efficiency of the parts within the set. By all means do a careful and neat wiring job, and be sure that the soldered joints are well made, with a clean, hot soldering iron.

It would be amusing to a good workman, to see some of the wiring on sets that many constructors have built and sent to the author for check-up. Great big globs of solder (the result of an inefficient iron) on every joint, besides having all the parts present the appearance of having been "thrown" into the chassis at random—without regard to layout design. Such workmanship will not go well with this little 2-tube receiver, and unless the constructor

is prepared to take some pains in the construction and wiring it may be advisable to postpone its construction to some later day.

LAYOUT OF PARTS

The layout of parts is well illustrated in the photos, and the wiring diagram is pictorially shown. All parts that are used are of standard manufacture, and available from practically any complete radio supply house. The aluminum case may be made up from sheet aluminum and corner posts, which also may be obtained from any supply house that specializes in short-wave parts; or may be purchased complete. A small section of aluminum between the two tubes serves to shield the tubes and various parts of each stage. The midget tuning coils are mounted on the upper shelf, and close to the grid-caps of each tube.

The flashlight cells are mounted within an aluminum bracket, as shown in the illustrations. Insulating washers between the top and bottom of each cell keep them from short-circuiting against the grounded case. This particular *(Continued on page 623)*

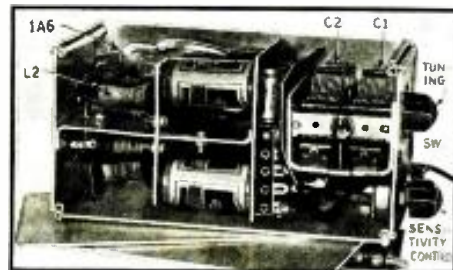
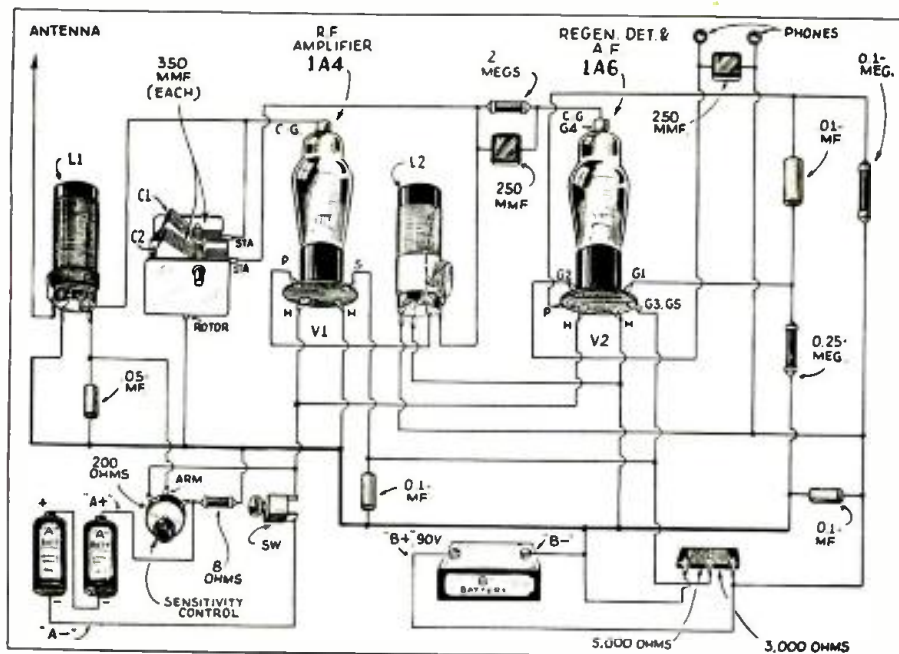

The picture wiring diagram appears at the left. Above is the top view of the set looking down on the coils and condensers. And below is a side view showing the volume control and one filament battery.

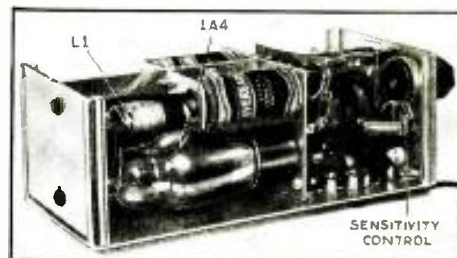

NEW RADIO AND INDUSTRIAL TUBES

A few of the remarkable new tubes as well as some of their outstanding uses are described for the benefit of those interested in electronic applications. Particular attention is given to several industrial types.

J. H. GREEN

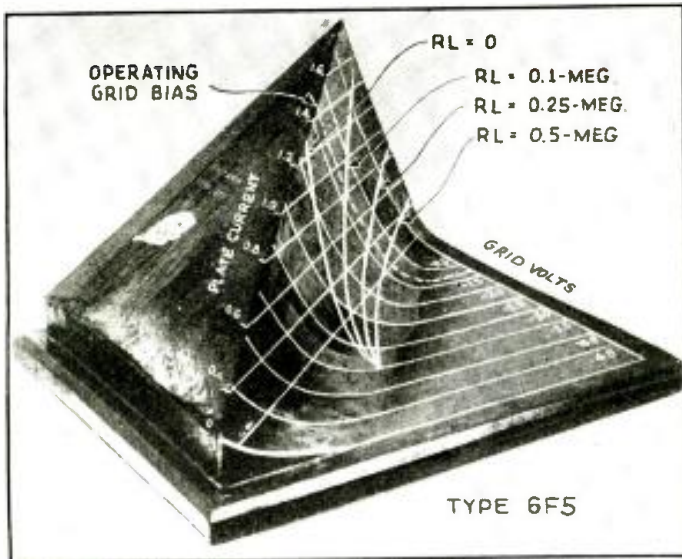
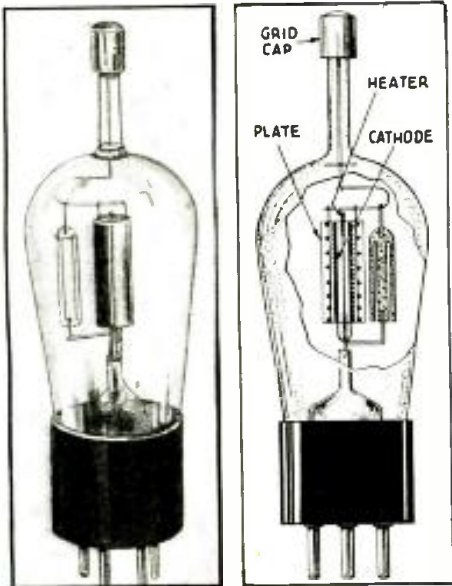

Fig. A, above. A 3-dimension tube chart. (Sylvania photo)



Figs. B and I. A new current indicator.

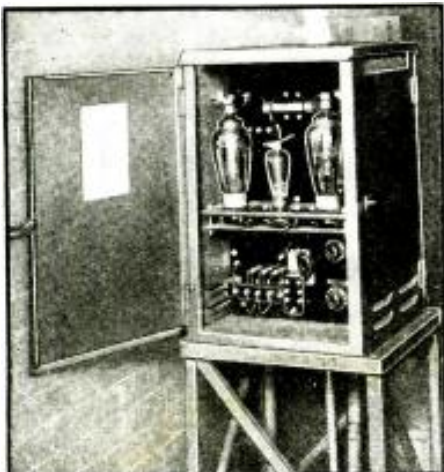
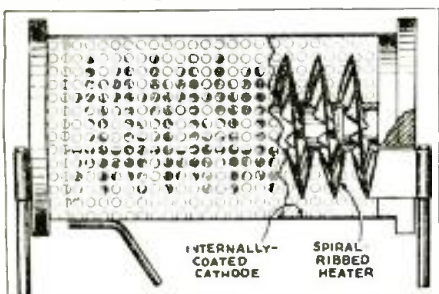

Fig. C, above, Fig. 2, below. New grid-glow tube.



ELECTRON TUBES have found many unique applications in industrial and manufacturing methods. Perhaps the best way to explain the extent of this application can be found in the statement of a well-known engineer who said "Show me the factory and I will show you how electron tubes will improve the system."

And the development of new tubes and applications has hardly started—at least, where industrial applications are concerned. Every day, new and more interesting uses are being found for these "magic bottles."

Incidentally the unusual photo at the top of this page, Fig. A, though remotely resembling the Rock of Gibraltar is actually a new type of characteristic curve, made by the engineering department of a well-known tube company. By showing the curvature of the grid-voltage plate-current characteristic in 3 dimensions, engineers are better able to picture the actual variations which take place with changing bias values and signal voltages.

The W. E. D-96475—a Super-sensitive Space-Charge Tetrode. This new tube, shown in Figs. B and I, is so sensitive that it compares favorably with the best electrometer—the instrument formerly used in physics and research laboratories for measurement of small currents. With a sensitive, laboratory-type D'Arsonval galvanometer as the indicating instrument this tube has a higher voltage sensitivity, shorter delay period, approximately equal capacity, greater ruggedness and more convenience of operation than the electrometer. The secret of this tube's extreme sensitivity is in the reduction of grid current to a value considerably lower than that in ordinary tubes.

This tube will find application in the laboratory to measure the ionization currents produced by alpha particles, neutrons, X-rays or cosmic rays; in astronomy to measure the minute photoelectric currents emitted by the stars; in biology to measure the extremely small currents produced by living tissues; and in industrial chemistry to measure the hydrogen ion content of solutions.

The KU-676—a Grid-glow Tube. Featured in this new device are: a built-in time delay for protecting the cathode when the tube is started up and a new cathode design resulting in a high peak-to-average current ratio.

Ultra-sensitive measurements may necessitate that this tube be shielded from light, from electric and magnetic fields, and from excessive vibration; it also may be necessary to surround the tube with an evacuated enclosure to reduce air ionization due to cosmic rays and stray radioactive material. In ordinary use, surface leakage may be minimized by washing the bulb surface with alcohol, and then by maintaining the bulb at above-room temperature or by coating it with ceresin wax; also, a grounded aquadag guard ring at the base of the bulb may be helpful. As an electrometer, operating voltages may be: filament supply, 4 V.; control-grid, $-2\frac{1}{2}$ V.; plate, 4 V.; space-charge-grid, 4 V., or less; (plate load, 0.1-meg.).

The unusual structure of the cathode in this tube is shown in Fig. 2. The directly-heated portion of the cathode is an edge-wound helix, which is closely surrounded by an indirectly-heated portion of perforated metal actinic only on the inside surface. The discharge is thus forced to pass through the perforations in the screen. This limits the excessive positive ion bombardment and high field strengths which have destroyed the cathodes in earlier types.

This improved grid-glow tube has many new uses, for instance in the time control of a spot welder—Fig. C.

(Continued on page 631)

Fig. D. The Knipp cold-cathode rectifier.

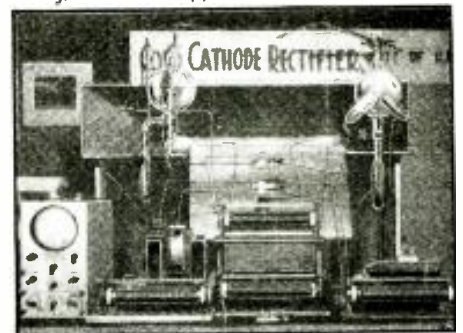

AN EASILY-MADE STROBOSCOPE FREQUENCY METER

This simple neon tube unit will give the experimenter a reliable audio-frequency meter.

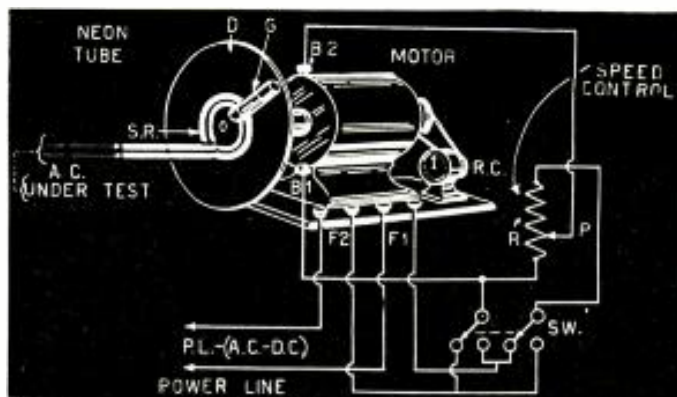

Fig. 1. Details of stroboscopic audio-frequency meter.

THE FREQUENCY-measuring device described below is very simple and can be easily built by any amateur. The frequency range is quite limited, but a considerable portion of the audio range can be covered with this instrument.

The principle consists in the application of the stroboscopic affect in connection with a gas-filled glow tube. We see in Fig. 1 an electric motor, M, the speed of which can be varied within a wide range by means of a rheostat, R. In addition, the direction of rotation can also be changed. An aluminum disc (or a phonograph record), D, about 8 ins. in dia., which is mounted on the motor shaft, carries a small neon glow tube, G, insulated from the disc (if it is metal).

One pole of the bulb is covered with paper, so that only the remaining pole remains visible. The alternating current is supplied to the bulb over 2 slide rings, S.R., mounted on the same shaft as the disc. A revolution counter, R.C., is mounted on the same baseboard as the motor and is operated by a belt from a revolving shaft over a reduction system. Thus the motor can be adjusted exactly to a given

number of revolutions. Any small fan-motor will do.

Changeover switch Sw. shown in Fig. 1, permits running the motor either in one direction or the other. The voltage applied to the rotor is controlled by changing the position of slider P on the resistor, R, shunted across the two brushes, B1 and B2.

MEASURING THE FREQUENCY

The frequency is measured in the following manner: The motor is started and the alternating current is applied to the glow tube. The speed of the motor is then so adjusted as to have the neon bulb glow, let us say, in 4 positions of the disc. It may happen that the 4 positions will slowly either advance, or move backwards; adjust slider P until the 4 positions remain stationary. The readings on the revolution counter will permit figuring the exact number of revolutions of the motor per minute.

Let us now work out an example, consider the motor is making, for instance, 630 revolu- (Continued on page 637)

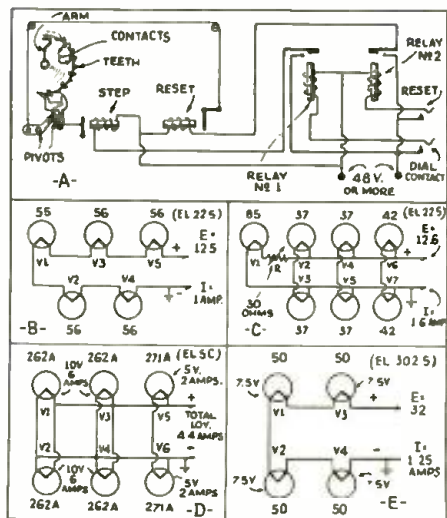

Fig. 1. Some filament circuits for D.C. operation.

MANY AN experimenter and owner of a large amplifier has wished that he knew how to eliminate hum.

Proper layout, and enclosing chokes, etc., in heavy iron castings, have helped, but some experimenters have been troubled with a lot of hum and have never been able to absolutely eliminate it. Where the 50-type or larger tube is used, and where one or more of the speakers in use has a decided peak anywhere from 60 to 120 cycles, then a strong filament hum is always heard.

USES OF LOW-VOLTAGE THERMIONIC RECTIFIERS

One answer to the question of hum-free amplification is the use of D.C. for the filament supply. An argon-filled rectifier tube is used to convert A.C. to D.C. at low voltages.

RUSSELL E. LANNING

The only way to eliminate all hum is by the use of *direct current* on all the tube filaments (except, perhaps, the power tubes). Power tubes such as the 50s should use separate filament supplies.

The writer has had many calls from various sources for humless apparatus using as many as 4 A.F. stages and type 845 tubes in the output. Batteries can be used, but never in an outfit for sale. Copper-oxide rectifiers at voltages above 2 or 3 V. are entirely out of the question, for they are not dependable and when they go bad they usually burn out a transformer or do other damage unless properly fused.

EQUIVALENT TO BATTERIES!

The thermionic-type rectifier tube is available today to supply high current

at voltages as low as 10 V. to tubes or other apparatus requiring heavy current (9 or more amperes). The particular tube to which the writer has reference is a full-wave device that is thoroughly dependable and when used in a properly designed chassis is as humless as any battery!

These tubes last for 1,000 hours at full-load and do not drop off in their efficiency, but go bad immediately, at the end of their life. When they are "done for," they do not harm associated apparatus. *They may be left lighted in circuit indefinitely with an intermittent load on the plates without harm and when used in that manner last for many years!*

The output, at any desired level within the rating of the tube, is steady. The writer is using (Continued on page 637)

PHILCO MODEL 59, 4-TUBE A.C. MIDGET SUPERHETERODYNE RECEIVER

(Broadcast band; police calls on lowest band; high sensitivity; high power output for its size.)

This midget superheterodyne operates only on 105-125 V. A.C. Total power consumption is 52 W. When tuning the set, use an accurate signal generator. To adjust I.F.T., remove cap lead of V1 and attach generator lead in its place. Set volume control at full-on position and receiver dial at 600, and set C1 and C2 for maximum output. Next replace cap on V1, and set receiver tuning dial so that condenser plates are just starting to mesh. Set signal generator at 1,400 kc. and tune in the signal by means of condensers C3 and C4. Replace the dial pointer in the proper position. An output meter should be attached to the primary of the output transformer.

The final adjustment must be made with the sensitivity control condenser, C5. With the set connected to an antenna, tune in a station at about 130 on the dial. With a

screwdriver, turn the small fibre hex-head screw which is located at the back of the chassis directly below the antenna and ground terminals, until the set squeals (circuit oscillates). Then turn the hex-screw 1/4-turn back until the oscillation stops. Tune in other stations at all parts of the dial to make certain that there is no squeal or oscillation at any point. If the tube V2 is replaced it will be necessary to readjust condenser C5.

Voltages are given in the following table:

Tube type	Fil. Volts	Plate Volts	S.-G. Volts	C.-G. Volts	Cath. Volts
V1	6.3	235	110	10.5	25
V2	6.3	45	35	0.25	15
V3	6.3	235	250	0.25	15
V4	4.8	300	—	—	—

All above voltages are taken with a line

supply voltage of 115 V. They should be taken from the underside of the chassis using test prods and a suitable A.C. voltmeter for the filaments and a high-resistance, multi-range D.C. instrument for all other readings. The volume control is set at maximum and the station selector at the low-frequency end of the band. Readings taken with a plug-in adapter will not be satisfactory.

The following table gives the color code of the power transformer:

Term.	A.C. Volts	Circuit	Color
1-2	105-125	Primary	White
3-5	6.3	Filament	Black
6-7	5.0	V4 Filament	Blue
8-10	580	V4 Plates	Yellow
4	—	CT 3-5	Blk.-Yel.
9	—	CT 8-10	Yel.-Grn.

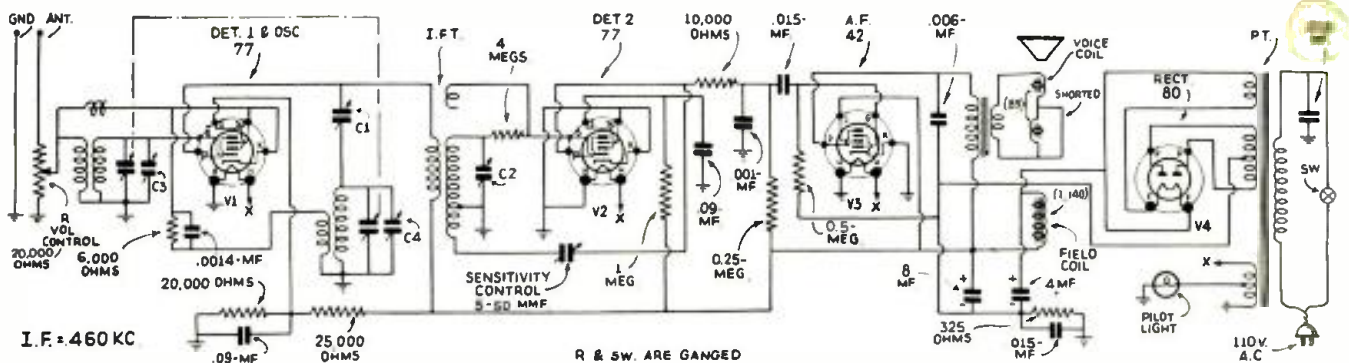

FORD-PHILCO RADIO, MODEL FT9, 6-TUBE AUTO-RADIO RECEIVER

(Special antenna circuit; dynamic speaker; non-polarized battery input leads; tone control; A.V.C.)

A fully-charged, heavy-duty battery should be used when testing this set. For all alignments an output meter should be connected to the plate of V5 and to chassis. The lead from the signal generator must be connected to the cap of V3 through a 0.1-mf. condenser. The tone control must be set at "brilliant" and the volume control set at maximum. The attenuator on the generator is set so that the signal is audible but not loud. Adjust C8 and then C7 for best output. Then remove the generator lead from V3 and connect it to the cap of V2 through the 0.1-mf. condenser. Adjust C6 and then C5 for best output. Remove the lead from V2 and connect to the cap of V1 through the same condenser. Adjust the signal generator to 1,600 kc. Turn the tuning condenser plates as far out of mesh as they will go, and in this position balance

the high-frequency padder, C3, and the R.F. padder, C2, for best response. This setting should correspond to 160 on the dial. Turn the receiver condenser to about 580 kc., 58 on the dial, and adjust the signal generator to the same position. Rock the tuning condenser back and forth at the same time turning the low-frequency padder, C4 for highest response. The high-frequency position should now be readjusted. Turn the receiver condenser plates out as far as they will go and adjust the generator to 1,600 kc. Then adjust the high-frequency padder, C3 again for maximum reading on the output indicator.

The antenna circuit is now tuned. Connect the antenna lead of the set to the antenna lead of the generator through a 125 mmf. condenser. Revolve the receiver condenser to 1,400 kc., and set the

generator dial at the same figure. Adjust padders C1 and C4 for highest output.

If the above procedure has been carefully followed the receiver will now be in alignment.

When the antenna stage is adjusted with the receiver installed in the car, the receiver antenna lead must be connected to the car antenna in the usual manner. The signal generator lead must be connected to a wire placed near the car antenna, but not connected to it.

No voltage readings are given for this set, since the manufacturer feels that they would be misleading, due to discrepancies in battery voltage, resistance of leads, and other variable factors. A slight change in signal voltage produces a relatively large change in operating voltages of the set.

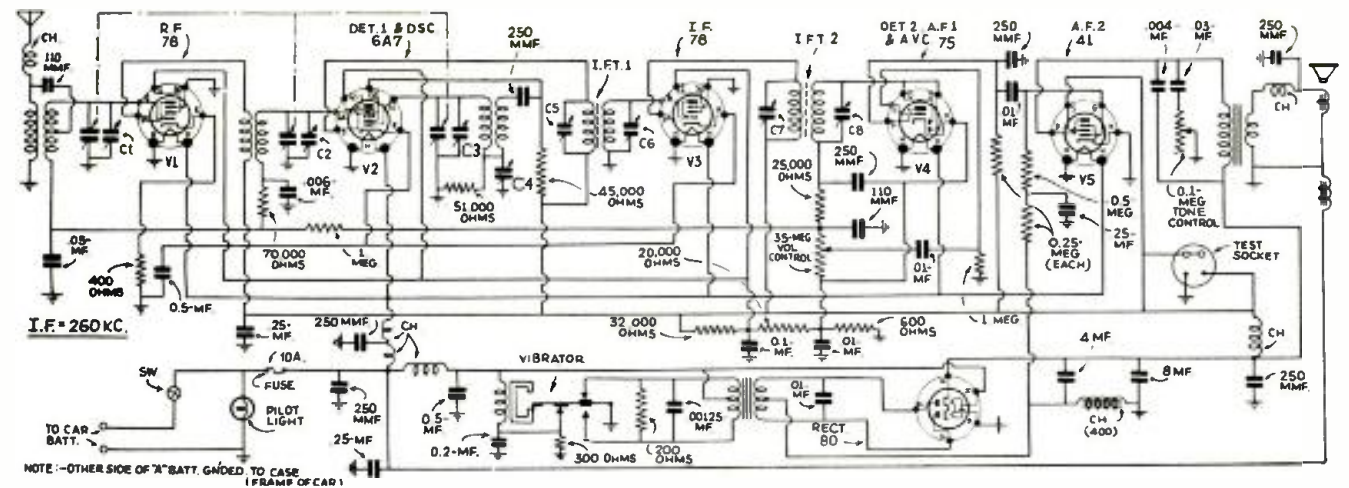

DIRECT-IMPEDANCE AMPLIFICATION

This is the first of a series of high-fidelity receivers which will interest the set builder.

PART I—A 10-TUBE SET

L. MITCHELL BARCUS

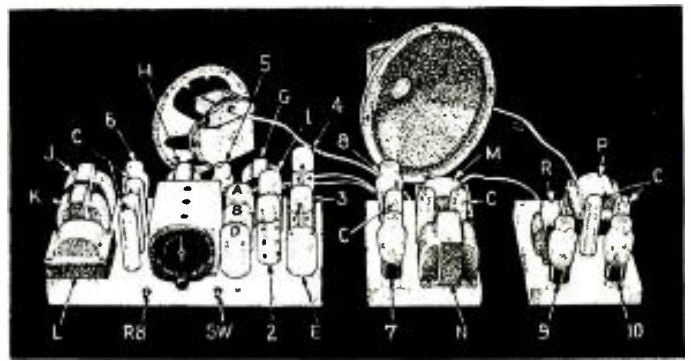

IT IS with considerable pride that this radio receiver is presented to the public for the first time. Designed especially in response to many requests for a receiver of moderate price, this circuit is the smallest and "easiest to build" of the series to follow. Here is an easily-constructed, low-priced radio receiver which will reproduce A 16 CYCLE NOTE at a much higher volume level than the balance of the audio range!

In the design of this series of radio sets, all the problems of present day reception were taken into consideration. Primarily, the serious dropping off of frequencies below 70 cycles presents the greatest handicap to perfect reproduction. (The author discussed this point in a preceding issue of *Radio-Craft*.—Editor) *It may be safely considered that no broadcast station of today transmits a 16-cycle note with even a near-approach to linearity compared with the balance of the A.F. range.* The only satisfactory manner in which these losses may be retrieved is by employing additional amplification. The use of boosters or resonant tuned circuits, as in transformer coupled amplifiers, fails to achieve the ultimate corrective factors. Further, all other amplifying systems themselves face the same attenuation of the low frequencies and these resonating circuits at best barely make up for their own inherent overall losses.

In the set described here, the exclusive "direct-impedance" circuit offers amazingly level response over the entire A.F. spectrum. Thus, given a practically flat 16-cycle output, the additional pentode amplifier stage brings even weak low notes up to a satisfactory level. It is this almost unbelievable performance in the lowest frequencies which

gives the set its characteristic mellow depth heretofore unobtainable.

"TUNING OUT" INDIVIDUAL MUSICAL INSTRUMENTS!

The importance of the low-frequency response, unbelievable as it may appear, is often not so much in the reproduction of the two bottom musical octaves, although these determine the entire character of an organ, as in the bringing out of the background noise to which we are accustomed in life. As an example of this we may, on the larger models which incorporate a low-frequency volume control, cut out the low response on a xylophone solo. While we have thus attenuated the lows *below* the effective range of the instrument, we still have the normal high-fidelity performance of contemporary radio receivers, a lifeless though accurate reproduction. By restoring the background, which may sound only like a series of soft thumpings and indefinable noises, the solo assumes a solid and convincing reality completely unlike the bare music.

To many, having never heard a low note on a radio set, the effect of the two bottom musical octaves is almost inconceivable. The entire *depth* usually associated with an organ is dependent on these vibrant notes and their absence alters the rich, soft music to the thin, piping effect normally heard on even the best of radio sets.

SIMPLICITY OF CONSTRUCTION

Should it seem that the construction of this receiver is difficult, it may be well to bear in mind that actually it offers fewer problems than many conventional sets. Both power units are ex-

remely easy to build, being little more than 2 speaker-field supplies.

The receiver itself is most conventional and is not designed to offer 'round-the-world reception and other features of no consequence to high-fidelity reproduction. The incorporation of some method of visual tuning indication is of value to builders who do not object to the slight additional expense. The usual 2nd I.F. stage has been omitted to cut down background noises and to offer less side-band cutting. While the variable-coupled type of I.F. coils have not been specified in this receiver, their use is not objectionable.

It is by no means fatal to vary the layout given in the heading illustration. As shown, however, there are several basic principles to which the builder must adhere. In the receiver unit, for example, it may be noticed that the power transformer (L) occupies the left corner with the 2 filter chokes (J and K) ranging along the left end. This placement segregates the power supply from the balance of the chassis, especially the two A.F. chokes (G and H) which may be seen behind the tuning condenser. The units in the heading photo correspond as follows with the symbols in Fig. 1: 1-V1; 2-V2; 3-V3; 4-V4; 5-V5; 6-V8; 7-V6; 8-V9; 9-V7; 10-V10; A-aerial coil; B-R.F. coil; C-C2; D-oscillator coil; E-first I.F. transformer; G-Ch.1; H-Ch.2; J, K-Ch.3 and Ch.4; L-Pt.1; M-Pt.2; N-Ch.5; P-Pt.3; R-Ch.6.

"HUM" CONSIDERATIONS

The mention of induced hum naturally calls for added discussion of that phase of construction. In view of the tremendous (Continued on page 638)

Fig. A (in heading) the appearance of the three chassis of the set. Fig. 1, below. The circuit of the set with its three-chassis construction.

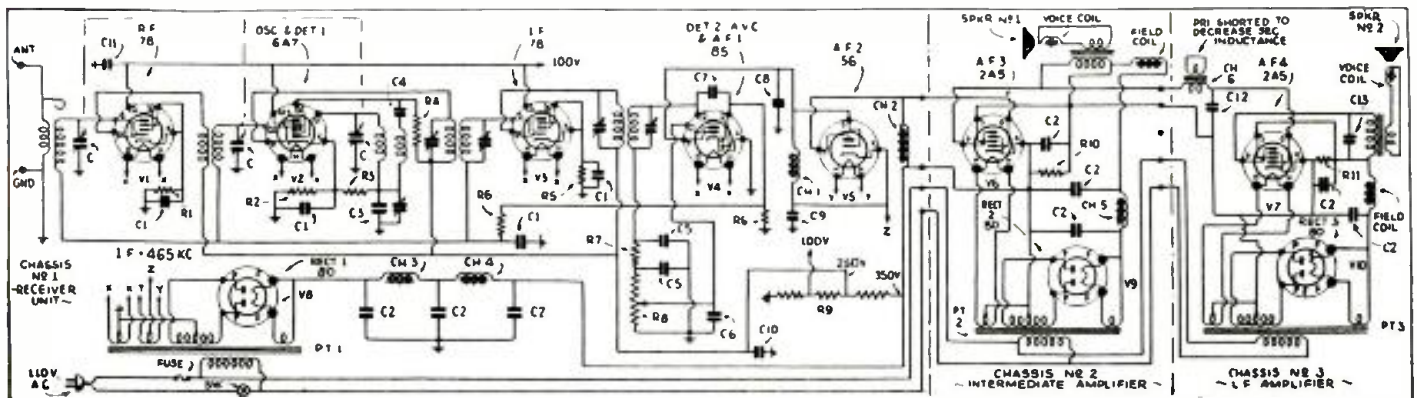

ZENITH FARM MODEL 6V 27, 6-TUBE SUPERHET. RECEIVER

(Low-drain tubes; class B output; bands: 550-1,780, 2,100-6,800, and 7,000-23,000 kc.; designed for 6 V. input and Zenith Wincharger.)



Voltages for this set are as follows:

Tube Type	Fil. Volts	Cath. Volts	C.-G. Volts	S.-G. Volts	Plate Volts
V1	2	1.5	0	70	125
V2*	6	2	0	70	150
V3	2	2	0	70	150
V4	6	1.5	0	40
V5	6	8	0	140
V6**	2	0	160

*Oscillator C.-G. runs at -1 V., plate at 150 V. **Voltages same for each section of tube V6.

All voltages are measured from socket contacts to ground with a 1,000-ohm-per-volt meter. Note that the filament is not a simple series connection, due to the fact that tubes with different filament voltage ratings are used together. No rectifier tube is needed, since a synchronous vibrator is employed.

Alignment procedure is as follows:

- 1—Attach service oscillator to control-grid cap of V2 and adjust trimmer condensers on I.F.T. 1 and I.F.T. 2 for highest output.
- 2—Place band switch in "A" or standard broadcast position and attach service oscillator to antenna and ground posts. Set service oscillator at 1,400 kc. and adjust trimmers "A," "B" and "C" as shown on chassis drawing for best output.
- 3—Set service oscillator at 600 kc. and rock dial indicator of receiver over 600 kc. on dial while adjusting broadcast padder "D."
- 4—Repeat both the above processes (2 and 3) to make certain of correct setting.
- 5—Place band switch in "B" position and set white pointer on 6 mc. Set service oscillator at 6 mc. and trim condenser "E" for highest output, while rocking dial pointer of receiver slowly over the 6 mc. division of the band.
- 6—Place band switch in "C" position and set dial at 18 mc. Adjust trimmer "F" to resonance while rocking receiver tuning condenser slowly over the 18 mc. division of the scale.
- 7—Set dial and service oscillator at 9 mc. and twist or untwist tinned bare wire loop (on front section of band switch under chassis) for highest output.
- 8—Align broadcast band "A" again by adjusting trimmer "A" only. Repeat all operations for highest possible accuracy.

All testing of this set should be done with a 6 V. battery. Note that the input leads to the set are polarized and must be connected in the proper manner to produce reception. If replacement is necessary, be certain to use the correct type of vibrator, as any other will give poor or no results.

Since this outfit is intended for use on farms or any other isolated location where commercial power is not available, it is necessary to use some other type of power to charge the 6 V. storage battery employed. The needed power is furnished by the Zenith

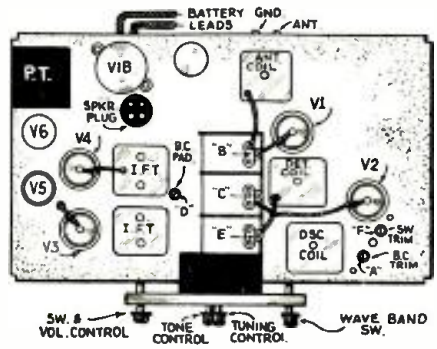

Above, a view of the general chassis layout, with tube and trimmer locations indicated.

Wincharger," an automatic windmill device, which keeps the battery in a charged condition. An assembly drawing of this instrument is given, from which its construction may be seen. The charger should be oiled and greased once a month. The generator cover must be removed in order to gain access to the rear bearing, and the terminal posts. If the generator causes interference in the receiver on the short-wave bands, a special switching arrangement is supplied by the makers which will allow the generator to run without harm although it is not charging. It should be noted that the generator will be damaged if allowed to run when it is not connected or not charging, unless the above mentioned switching arrangement is used.

The necessary connections to the battery and controls are made from the charging panel, a drawing of which is shown. The meter thereon will indicate the rate of charge or discharge of the battery. If repairs have been made to the generator or panel it is best to test these units for correct operation before they are put in use. This can be easily done by connecting a short piece of copper wire between the upper and lower connections of the relay. This shorts the relay and makes the charging generator act as a motor, which will revolve the propeller and cause the meter to show a discharge of about 4 A. This is a positive check of connections in the circuit. The same connection may be made if the machine is new and stiff or if the lubricant is cold, to start it turning.

No connections are shown to the receiver from the battery, in the diagram of charger connections. The receiver is simply connected directly across the battery, care being taken to observe the proper polarity. Wire no smaller than No. 8 B & S gauge should be used for this purpose. Wire from charger to battery should be No. 8, up to 50 ft.; No. 6 up to 100 ft.; No. 4 up to 200 ft.

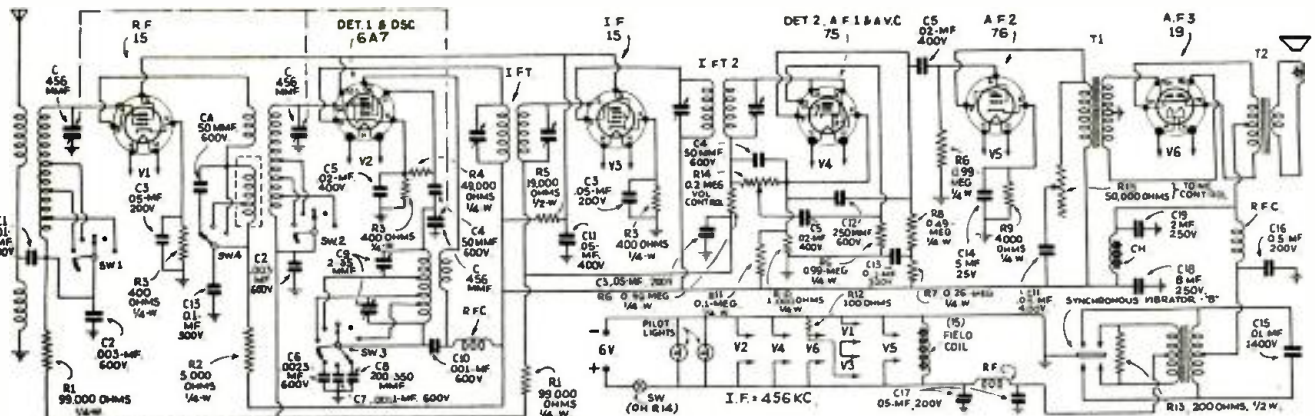
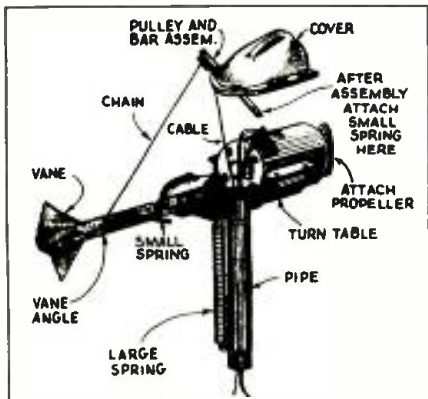
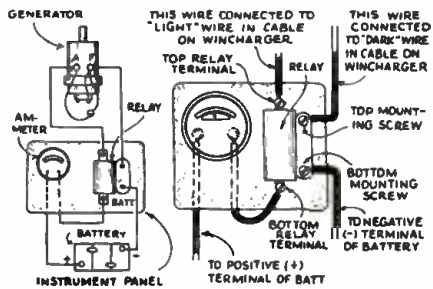

WARD 10-TUBE ALL-WAVE HIGH-FIDELITY SUPERHET., SERIES ODM

179-194-200
216 218

(Features: undistorted power output, 5 W.; ranges, 535-1,730, 1,715-5,800, and 5,750-18,000 kc.; variable band width intermediate; metal tubes; available for any power supply; dual volume control.)

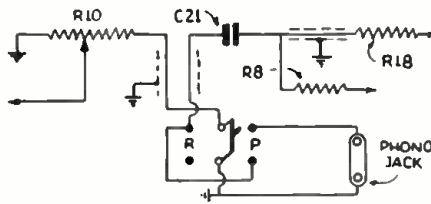

The socket voltages of this receiver are as shown in the table:

Tube Type	Heater Volts	Plate Volts	S.-G. Volts	Cath. Volts	Cath. Ma.
V1	6.1	265	120	3.7	9.0
V2	6.1	265	110	9.5	3.8
V3	6.1	265	120	3.7	9.0
V4	6.1	265	120	3.7	9.0
V5	6.1	110	0	5.8
V6	4.9	0	90
V7	6.1	265	14	5.0
V8, 9	2.5	265	50	22
V10	6.1	0	0	0

These readings are taken with antenna shorted to ground and volume control at maximum. The line voltage should be 115 V. Heater voltages are read across the heater or filament prongs, all other voltages from prong to ground. The total power consumption of this outfit is 90 W. at 115 V.

The circuit alignment is accomplished according to standard practice. Alignment

frequencies are: 456, 1,730, 1,500, 600, 5,800, 5,000, 18,300, 15,000, and 6,000 kc. It is absolutely necessary to use a signal generator and an output meter for alignment work. The selectivity control should be turned to the "sharp" position and left there for all adjustments. The band switch must be in the "B" range or broadcast position when aligning the I.F., and the volume control at maximum point. Care must be exercised to set the attenuator of the service oscillator at the minimum position necessary to secure a satisfactory reading on the output indicator, in order to prevent A.V.C. action from causing false readings.

It will be noted that a dual volume control is used, and that section R3 is shorted out when the band switch is turned to the second short-wave position. When not shorted, this control functions to lower the sensitivity of the receiver at low-volume settings, to cut down the noise pick-up between stations.

The average sensitivity of this set on the various bands is as follows: "B" range, .7-microvolt, absolute; "C" range, 1. microvolt, absolute; "D" range, 2 microvolts, absolute. It may be found in certain cases that when a station is tuned in with the selectivity control in the "broad" position, the station will disappear when the control is turned to the "sharp" position. This is normal and does not indicate any fault or misalignment of the receiver.

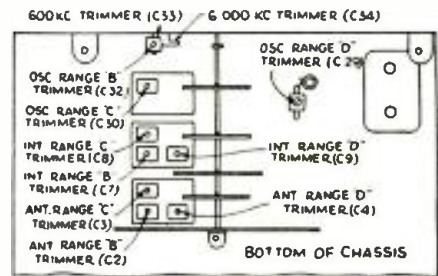

The locations of the various trimmers in the receiver are shown on the small diagram. The "C" numbers correspond with those on the main diagram.

Another small diagram is given showing the necessary connection to be made for the use of a phonograph pickup. A good quality, high-impedance pickup must be used. A low-impedance pickup will necessitate the use of a matching transformer.

On some early models of this receiver, the tone control was connected as a series resistor, rather than as a potentiometer. The resistor, R18, was not used in early models. The 6K7 metal tubes replace the 6D6 tubes. Condenser C35 is not used in all models.

The resistance values of all inductances are shown on the diagram in the form of small figures in parentheses. Those marked (X) are too low for accurate measurement.

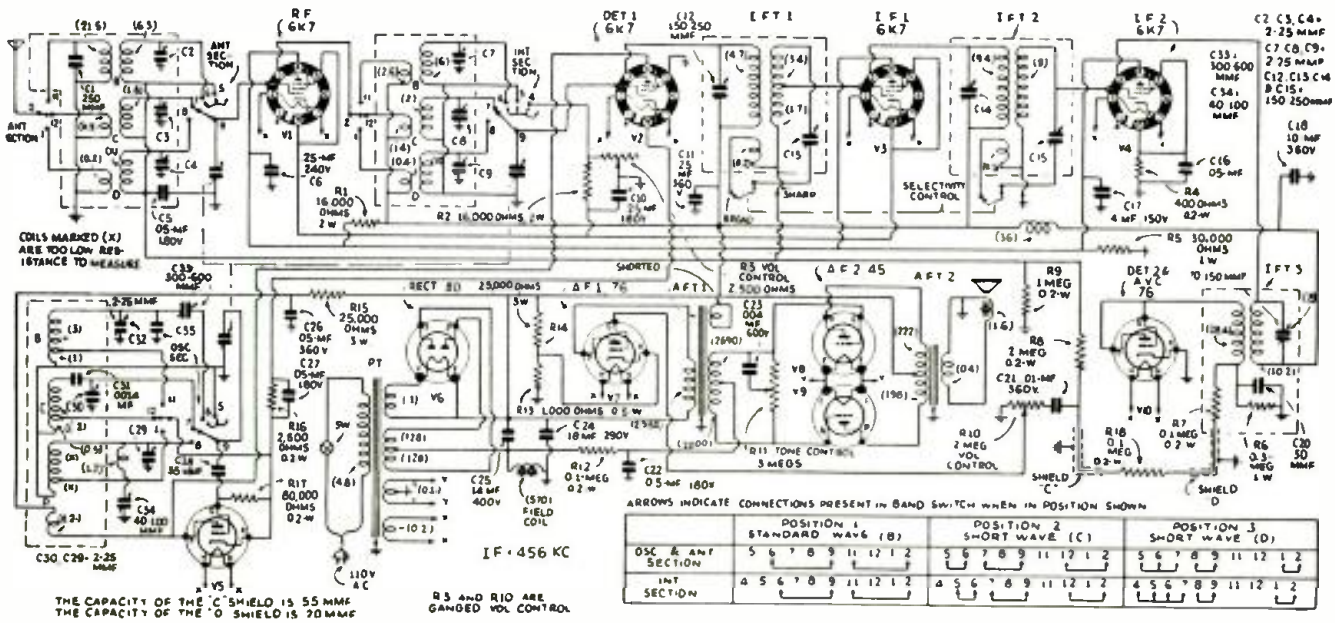

INTERNATIONAL MODEL 66 AND 666, 6-TUBE SUPERHET.

(Uses regulator tube; dual band; A.C.-D.C. operation.)

Alignment should be made by use of output meter and service oscillator. Set latter at 448 kc. and attach lead to set antenna connection. Align I.F.T. 1, then I.F.T. 2 for maximum output. Place band switch at

broadcast position, turn set to 1,400 kc. and feed a very weak 1,400 kc. signal from service oscillator to antenna. Adjust trimmers on gang condenser for best response. Adjustment at 1,000 and 600 kc. must be made by

carefully bending plates of tuning condenser.

Socket voltages are as below:

Tube Type	Cath. Volts	Sup.-C. Volts	S.-G. Volts	Plate Volts
V1	14	0	100	100
V2	1	1	100	100
V3	5	65
V4	0	..	100	87
V5	100	35

Line voltage should be 118 V., and volume control full on. A variation of 10 per cent is allowable. All measurements made from tube prong to circuit ground.

No alignment is necessary for the short-wave band since this is accomplished automatically. As a rule poor sensitivity is a sign of incorrect I.F. alignment, which should be carefully checked in such cases.

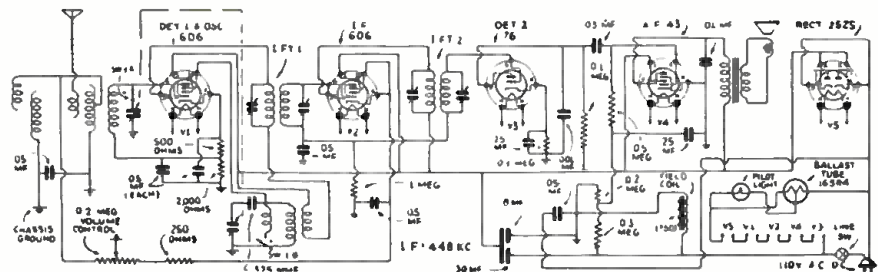



A department devoted to members and those interested in the Official Radio Service Men's Association. It is the medium for exchanging ideas, kinks, gossip and notes of interest to Service Men, or others interested in servicing.

THIS MONTH'S SHOP PHOTO

RADIO-CRAFT, ORSMA *Department*:

I am enclosing a photo of my service bench (Fig. A). This was taken at a time when we were "rushed to death," so it looks rather mussed up.

I read the ORSMA Members' Forum page first, always, and believe it to be helpful to all Service Men who read it.

MYLO H. CANDEE,
Pasco, Washington.

Everything seems to be handy to the Service Man in this shop. Note the tool panel and well-stocked tube shelf. This is a hint to many who do not have such convenient facilities.

AN ODD TROUBLE

RADIO-CRAFT, ORSMA *Department*:

Recently, I had a rather baffling condition while repairing a Crosley receiver, of a type using 2 wet electrolytic condensers. A flat-type resistor had been found defective and the set had to be turned upside down and on its side before this resistor could be replaced. When the job was finished and the set turned right side up it was found to be inoperative. A complete test of all voltages showed everything to be in perfect shape but no signals could be heard. Yet every tube, every voltage and every circuit tested OK.

A final last check revealed that while working with the set on its side, a small amount of the liquid from the electrolytic condensers had dripped out and fallen between the condenser plates, thus shorting several sections and effectively grounding the grid circuits of several of the tubes. A blotter, carefully applied, absorbed the liquid and normal operation was soon restored.

I submit this in the hope that it may help some other Serv-

Fig. 1. This drawing was submitted in our "Ideal Service Shop" contest by Mr. F. T. Holmes, of Old Town, Maine. Although it did not win a prize, it was thought sufficiently interesting to warrant publication as a novel hint to other Service Men.

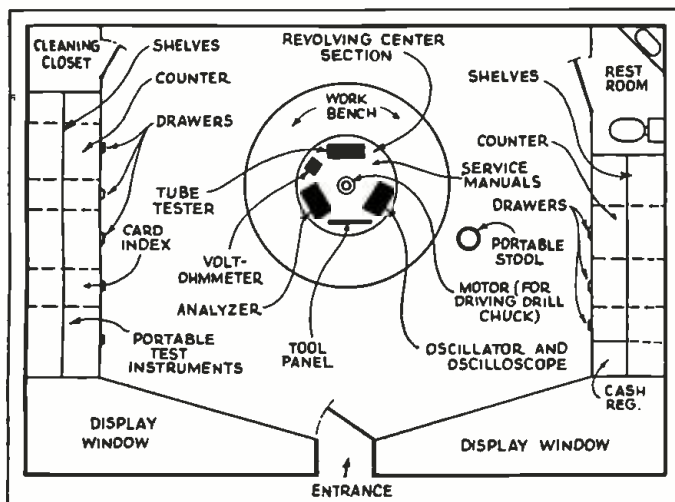

Fig. A. The Service bench of Mr. Candee, which appears to be very conveniently arranged.

ice Men who have run up against the same stumbling block.

RICHARD R. STAN,
Pittsburgh, Pa.

FROM A PROSPECTIVE MEMBER

RADIO-CRAFT, ORSMA *Department*:

Although I am not a member of ORSMA I would like to say some things about this valuable department.

All 3 articles in your January number interested me. When I read Mr. Musson's article I was about half-through shielding my shack with copper screen. It has been the Devil's own job and I have been wondering whether to finish it or not, but after reading this I have decided to complete the job.

The next article gave me a laugh. I had such an experience myself several years ago, only in this case I found a large family of mice had been "squatting" in a Fada console.

The last, but not least, article is a sticker. My idea of servicing sets at home is "all or nothing." I carry a Supreme 89D tester and a Supreme 189 signal generator on all service calls, and I find that with a good stock of tubes and a few selected tools I can take care of about half the jobs. But for a complete and well done job one must have so much at hand that I believe the shop work bench with its convenient equipment, tools, and parts is the proper place.

I am interested in joining ORSMA. Please send details.
J. FRED GAGNON,
East Harwich, Mass.

A JUST COMPLAINT

RADIO-CRAFT, ORSMA *Department*:

I wonder if you could help me out of a little difficulty. I reside in an apartment, and downstairs and a few doors to the east is located a branch store of the National Tea Co. They have recently installed a combination cash register and adding machine which is run by an electric motor. The latter is not equipped with a (Continued on page 637)

MUSICAL STATIC

(Continued from page 584)

MUSICAL "STATIC"

A violin was equipped with small pieces of metal foil (from a cigarette package) in positions A and B in Fig. 3 and these strips were connected to the input of the amplifier, in turn. Some success resulted, but it was found that sharp motions of the bow caused sounds similar to static to be amplified. Finally a fine wire was wrapped around the wooden frame of the violin bow (C) and this wire connected to the amplifier. This gave much greater volume—and the quality for sustained tones was much better than in the other two methods. However, in this case, too, the static sounds were heard when the bow struck the strings sharply.

While limited in its scope, these experiments with the violin—in which metal, gut and wire-wound strings were vibrated by the horse-hair of the bow—definitely established the effect as one of friction. It will be noted that no rubber was used in the last experiment, thus showing that any substance with strong static-electrical effects (in this instance, the resined bow) may be used.

THE RUBBERBAND "HARP"

The last experiment—and perhaps the most successful one from a musical standpoint—consisted of stretching rubberbands across a metal plate between bindingposts in such way that one set of the bindingposts could be turned, to tune the strings. Then by tuning the strings like a harp or piano and plucking the bands lightly, a very fine electronic musical instrument was produced. The sounds did not remotely resemble those ordinarily produced by stretched rubberbands when plucked near ones ear. The instrument has a rich, musical tone which is especially fine on the bass tones. (See Fig. A.)

In the small experimental model, covering one chromatic octave, which was made, tones as low as low C could be produced with all the beauty of a grand piano—but with an individuality of tone quite its own.

The amplifier used in the experiments outlined above, as shown in the photos, had a gain of 130 db. and an output of 15 W. It was designed for Public Address work—but any high-gain amplifier will serve.

The electronics experimenter will find an interesting subject in this static effect—and who knows, perhaps an even more useful development than the "Band-O-Phone"—as we call the rubberband "harp"—may be discovered!

(Credit is hereby given to *The Review of Scientific Instruments* and Indiana University for the basic idea presented above. All practical applications such as the microphone, violin pickup and "harp" were devised by the staff of *Radio-Craft*.—Editor)

AN A.C.-D.C. ELECTRONIC RELAY

(Continued from page 589)

high sensitivity, and is easy to set up and adjust. It has been found that a person can hold a hand stationary at a distance of several feet from the antenna and turn the relay on and off just by pointing and then lowering one finger! The device does not create interference in radio receivers, because the power output of the oscillator is small and the wavelength of oscillations is above the broadcast band. The sensitivity of the circuit, that is, the distance between hand and antenna at which the relay operates, is controlled by adjustment of C3 and R2. The maximum plate current of the 25A6 is adjusted to a value sufficient to close the relay by adjustment of R3. The antenna can be a piece of tinfoil glued to the show window. The oscillator coil can be a commercial type of 8-mhy. center-tapped R.F. choke. This coil should be mounted close to the 6Q7 socket so that leads can be short. It will be seen that since the circuit operates directly from a 110-V. line, no power pack is necessary. However, because of the direct connection to the line, the whole circuit, except the antenna and antenna-lead, should be enclosed in a box so that there is no danger of shock or of shorting the power line to ground. And if a metal chassis is used, care must be taken to avoid shorting either the metal shielding of the tubes to chassis; or, the chassis to a grounded object.

This article has been prepared from data supplied by courtesy of RCA Manufacturing Co.

WHEN SELECTING YOUR SERVICE-TEST EQUIPMENT



* Triplett tube testers and panel instruments—approved for time payment sales under F.H.A. plan.

TRIPLETT TWIN
Used as standard
equipment in No.
1200 Volt-Ohm Milli-
ammeter Unit.

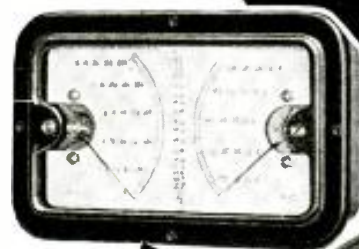

Master Unit Model 1200
Volt-Ohm Milliammeter.



MASTER UNIT TEST SET, Model 1206—
A Complete servicing laboratory consisting of four separate units. Each can be purchased separately.



SEE YOUR
JOBBER

Model 1206 complete. Dealer Net Price—\$82.67



Triplett Electrical Instrument Co.
164 Harmon Drive, Bluffton, Ohio.
Please send me complete information on
Model 1206 Send New 1936 Catalog
Name
Address
City

THOR'S Latest P.A. 5-Tube Hi-Fidelity Amplifier

Has less than 2 db variation between 20 to 14,000 cycles. Rated Gain 75 db. Power output 16 watts continuously and peak of 20 watts. This sensational performer is built around the following tubes (1)-RCA83V—(1)-RCA56—(1)-RCA57—(2) 2 B6's, Tubes Specially priced at \$3.95.

Completely wired and tested less Tubes \$14.95
Ready to operate less Speaker

Rola G 12" Hi-Fidelity speaker with output transformer to match.....\$10.45

Rola 12" K-12 speaker to match.....\$3.95

Order direct from this ad.
MAIL ORDERS PROMPTLY FILLED



767 GREENWICH ST. NEW YORK, N. Y.

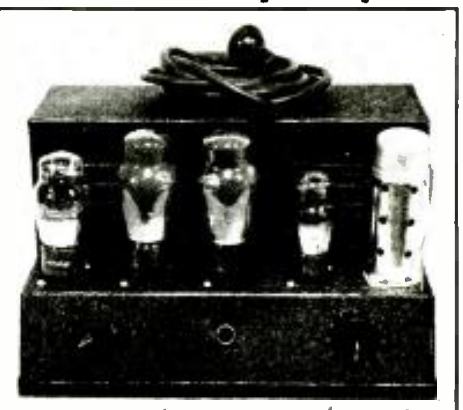



Licked 4 tough problems

Case No. 1 Stuck on a set with an unfamiliar QAVC circuit. They spent long hours tracing trouble and studying manuals in vain. Finally they turned to MODERN RADIO SERVICING and there on page 473 found a complete description of this very QAVC circuit. With that they located the trouble in ten minutes and soon had the set working perfectly.

Case No. 2 A low-priced a.c.-d.c. midget had some kind of "tunable hum" trouble they had never run across before. MODERN RADIO SERVICING gave them the causes and remedies on pages 628 to 630, and the hum was completely and quickly eliminated by simply connecting a 0.001 mfd. condenser from one side of the power line to ground. Hours were saved!

Case No. 3 Two previous service men had completely given up on an Amrad Model 7100 troubled with intermittent reception. But this service shop turned first to RADIO FIELD SERVICE DATA (Supplement to MODERN RADIO SERVICING), and there on page 33 of the "Case History" section found that "leads shorting in the cabled wiring" might be the trouble. The book was right—and the customer delighted—to say nothing of the service men!

Case No. 4 This shop had two good technicians, but neither one had the "selling knack," and their advertising never seemed to "pull." In MODERN RADIO SERVICING they found a 59-page chapter that gave them scores of practical tested tips on selling and advertising. They tried out a few and now their only problem is catching up with the orders!

Here's the one book that has everything you need to know

MODERN RADIO SERVICING

by Alfred A. Chirardi

1300 pages, 706 illustrations. Together with 240-page Supplement.

\$5 RADIO & TECHNICAL PUBL. CO. 45 Astor Place, N.Y.C. Dept. RC-46

- Enclosed please find \$5 for Your Introductory Combined Offer of both books post-paid (foreign \$5.50).
- Please send free descriptive literature.

NAME _____
ADDRESS _____

- What kind of information do you need most?
- Test instruments? Latest test methods?
- Latest repair methods? Case Histories?
- Sells and advertising

Read the review of MODERN RADIO SERVICING in March RADIO CRAFT

TECHNICIANS' DATA SERVICE
JOSEPH CALCATERRA DIRECTOR

A special arrangement between RADIO-CRAFT magazine and the publishers of this literature, which permits bulk mailings to interested RADIO-CRAFT readers, eliminates the trouble and expense of writing to each individual organization represented in this department.

2. HAMMARLUND 1936 CATALOG. Contains 12 pages of specifications, illustrations and prices on the new line of Hammarlund variable, mid-get, band-spread and adjustable condensers; trimming and padding condensers; R.F. and I.F. transformers, coils and coil forms; sockets, shields, chokes and miscellaneous parts for ultra-short-wave, short-wave and broadcast operation.

3. HOW TO GET A HAMMARLUND 1936 SHORT-WAVE MANUAL. A circular containing a list of contents and description of the new 16-page Hammarlund Short-Wave Manual, which contains construction details, wiring diagrams, and list of parts of 12 of the most popular short-wave receivers of the year.

4. THE "COMET PRO" SHORT-WAVE SUPERHETERODYNES. Describes the outstanding features of the standard and crystal-type Hammarlund "Comet Pro" short-wave superheterodynes designed to meet the exacting demands of professional operators and advanced amateurs for a 15 to 250 meter code and phone receiver, but which can be adapted by anyone for laboratory, newspaper, police, airport and steamship use.

5. ELECTRAD 1936 VOLUME CONTROL AND RESISTOR CATALOG. Contains 12 pages of data on Electrad standard and replacement volume controls. Tru-volt adjustable resistors, vitreous wire-wound fixed and adjustable resistors and voltage dividers, precision wire-wound non inductive resistors, center-tapped filament resistors, high-quality attenuators, power (50- and 150-watt) rheostats and other Electrad resistor specialties.

57. RIBBON MICROPHONES AND HOW TO USE THEM. Describes the principles and operating characteristics of the Amperite velocity microphones. Also gives a diagram of an excellent humless A.C. and battery-operated preamplifier.

62. SPRAYBERRY VOLTAGE TABLES. A folder and sample pages giving details of a new 300-page book, containing 1,500 "Voltage Tables" covering receivers manufactured from 1927 to date, published by Frank L. Sprayberry to simplify radio servicing.

64. SUPREME NO. 385 AUTOMATIC TESTER. A technical bulletin giving details, circuits and features covering this new Supreme development designed to simplify radio servicing. In addition to the popular features of Supreme analyzers and tube testers it contains many direct-reading features which eliminate guesswork or necessity of referring to charts or tables.

67. PRACTICAL MECHANICS OF RADIO SERVICE. Information, including cost, features and outline of lessons of the Frank L. Sprayberry course in Radio Servicing, and list of Sprayberry Data Sheets for modernizing old radio equipment.

73. HOW TO ELIMINATE RADIO INTERFERENCE. A handy folder which gives very complete information on how to determine and locate the sources of radio noise by means of the Sprague Interference Analyzer. A description of the analyzer and method of using it is included, together with data on how to eliminate interference of various kinds once the source is located.

74. SPRAGUE 1936 ELECTROLYTIC AND PAPER CONDENSER CATALOG. Gives specifications, with list and net prices on a complete line of wet and dry electrolytic, and paper condensers made by the Sprague Products Co. for radio Service Men, set builders, experimenters and engineers. Information on the Sprague Capacity Indicator, for making capacity tests on condensers and in servicing receivers, is included.

75. SPRAGUE TEL-U-HOW CONDENSER GUIDE. A valuable chart, compiled by the Sprague Products Co. which tells the proper types, capacity values and voltages of condensers required in the various circuits of radio receivers and amplifiers, and how to locate radio troubles due to defective condensers. Includes data on condenser calculations.

76. FACTS YOU SHOULD KNOW ABOUT CONDENSERS. A folder, prepared by the Sprague

Radio-Craft Technicians' Data Service
99 Hudson Street,
New York City, N.Y. RC-436

Please send to me, without charge or obligation, the catalog, booklets, etc. the numbers of which I have circled below.

2	3	4	5	57	62	64
67	73	74	75	76	77	

My radio connection is checked below:

- Service Man operating own business.
- Service Man for manufacturer.
- Service Man for jobber.
- Service Man for dealer.
- Service Man for servicing company.
- Dealer.
- Jobber.
- Experimenter.
- Professional Set Builder.
- Amateur Set Builder.
- Short Wave Work.
- Licensed Amateur.
- Station Operator.
- Radio Engineer.
- Laboratory Technician.
- Public Address Worker.
- Manufacturer's Executive.
- Student.

I am a:

- Subscriber Newsstand reader

I buy approximately.....of radio material a month. (Please answer without exaggeration or not at all.)

Name

Address

City..... State.....
(Please print name and address)

Avoid delay. The catalogs and booklets listed are now in stock and will be sent promptly as long as the supply lasts. Please use this coupon in ordering. The use of a letter causes confusion and delay.

Products Co., which explains the importance of various characteristics of condensers, such as power-factor, leakage, capacity and voltage in determining the efficiency or suitability of a given condenser to provide maximum filtering and safety in operation.

77. SUPREME 391 P.A. ANALYZER. This booklet describes the features and use of the new Supreme 391 P.A. Analyzer, designed to equip the radio Service Men to cash in on the constantly growing opportunities for service in the sound equipment and public address systems used in movie theatres, schools, churches, auditoriums, etc.

THE RADIO MONTH IN REVIEW

(Continued from page 583)

tems, refrigerators and other forms of man-made static and will, to some extent reduce natural static, though it is not a "static eliminator."

Mr. James J. Lamb who designed the new unit stated: "The general principle comprises one tube paralleling a tube in the receiver's I.F. amplifier, followed by a rectifier. The rectified noise currents are fed back through a circuit and applied to a previous tube in the receiver to block or render that tube inoperative for the duration of the noise impulse.

"The period the device is active may be so small that the ear does not perceive any change in the program quality."

In other words, this device is a special type of automatic volume control!

NEWEST APPLICATIONS OF ELECTRONICS

(Continued from page 586)

the light will be modulated with your voice instead of the 60-cycle variations of the power line. By this means, you have accomplished the seeming impossibility mentioned above—you have made your voice modulate a light beam.

For those interested in the amplifier shown in Fig. 2, the following values apply:

- T1—A.F. Transformer;
- T2—Power transformer, 600 V., center-tapped high-voltage winding, 5 V. filament winding, and two 2.5 V. filament windings;
- R1—60-ohm resistor, center-tapped;
- R2—13,100-ohm resistor;
- R3—1,500-ohm, 1-W. resistors;
- R4—10-meg. resistors;
- R5—0.1-meg. resistors;
- R6—1-meg. resistor;
- R7—2,500-ohm, 1-W. resistor;
- C1—.01-mf. condensers;
- C2—2 mf. condensers;
- C3—7 mf. condensers;
- Ch.1—output choke;
- Ch.2 and Ch.3—30 hy. filter chokes;
- "B"—90 V. battery.

OIL-WELL WATER INDICATORS

The electronic engineer has even invaded the oil fields, for in Figs. 3 and 4 we have equipment which will locate with great accuracy, the depth at which water is entering an oil well. In the past, efforts have been made to make such measurements, but the general method has been to add to the contents of the well, such materials as will make the liquid electrically conductive, then to measure the amount of such conductivity at various levels.

The newest scheme operates on the principle of the difference of light conductivity of liquid, as measured by a photoelectric cell. The results are said to be more uniformly accurate, and the test may be made much more quickly.

The method is very simple. The well is first "conditioned," by dumping in a quantity of mud or dye which will uniformly color the water and lower its light conductivity. The mixture is circulated so as to form a uniform density. A test run is then made with the instrument and a graph drawn from the readings of the associated meter. Then a quantity of the water in the drilling is bailed out to allow the so-called "formation water" to enter. The water locator is then again dropped down the shaft and the meter readings plotted on the graph. Next, a third run is usually made after more water has been bailed out. The last run is made after mixing the fluid near the source of the formation water with the bailer. The 4 curves are then studied and the source of the water can be very accurately determined.

The actual locator is quite simple in construction, as may be seen by reference to Fig. 3B. At the extreme bottom is a screw switch, by means of which the light is turned on before the apparatus is dropped down the shaft. The water enters a passage at the bottom of the casing and passes up over the lower lens and out the side of the casing. In doing so it intercepts the light beam to the P.E. cell, which is located directly above. This interception causes changes in the current through the P.E. cell which are transmitted through the cable to the meter on the surface.

The simple circuit used is shown at Fig. 4.

AN AUTOMATIC ELECTRONIC POTENTIOMETER

(Continued from page 598)

the final readings. Changes in supply voltage, vacuum-tube characteristics, photo-cell efficiency, light-source intensity, etc., lie outside the critical circuit. Thus, the instrument can be used on the regular power supply, and need not be checked against a standard cell. The standard resistor is arranged for plug-in connection, so that the range of the instrument may be changed at will.

This article has been prepared from data supplied by courtesy of Weston Electrical Instrument Corp.

Allied Radio CORPORATION

833 W. JACKSON BLVD., Chicago

FREE MAIL THIS COUPON

ALLIED RADIO CORP. Dept. D
833 W. Jackson Blvd., Chicago.

Send me your FREE NEW SPRING AND SUMMER 1936 RADIO CATALOG.

Name

Address

NOW The Perfect! CODE TEACHER!

The NEW Master Teleplex

For beginners, experienced operators, and schoolroom. The sure easy way to learn code and to step up your speed. This amazing new instrument will record your own sending on double row perforated paper and repeat it back to you at any speed you desire. 10,000 words can be recorded on one tape.

No Batteries * No Winding All Electric

It is the same in principle; and in operation is equal to the Wheatstone Perforator and Transmitter, which cost over \$1,000.

Buy It or Rent It

Send for Folder M1, which tells you how to get the use of this instrument without buying it. No obligation. We furnish complete course and personal instruction with a money back guarantee. Low cost, easy terms. Write today for information.

TELEPLEX CO.

72 Cortlandt St. New York City
The New Master Teleplex—"The Choice of Those Who Know"

STENTORIAN SOUND AMPLIFIER NUCLEUS

REMEMBER!—Build your Amplifier STENTORIAN way—for powerful clear volume at low cost. For stations, call systems, lodges, banquets, advertising, etc.



NUCLEUS includes "Pull-Push" moisture-proofed transformer, chokes, audios, outputs and lettered chassis, 6-10-15-30 watt amplifiers. A, AB power, 2.5, 6.3 v. tubes. Also for mike Pre-Amplifiers; and battery amplifier.

FREE!—Send for full details and illus. bulletin—STENTORIAN Amplifier Nucleus and name of your distributor.

General Transformer Corp.
504 S. Throop St., Chicago

Manufacturers of Replacement Units

Train at Home Under FACTORY ENGINEERS for GOOD PAY Spare-Time and Full-Time Jobs in RADIO



LEARN TO EARN UP TO \$75 A WEEK

If you're dissatisfied with small pay—and an uncertain future, get my big FREE book, "RADIO'S FUTURE AND YOURS." This book tells how you can learn at home under the supervision of factory engineers to make more money almost at once in Radio—how to make Radio your life's work, or how to earn \$5 to \$20 a week extra in your spare time.

MORE OPPORTUNITIES THAN EVER BEFORE

1935 was Radio's biggest year. Over 5 million new sets sold. Over 30 million dollars paid for service alone. Where only a few hundred men were employed a short time ago, thousands are employed today. And where a hundred jobs paid up to \$75 a week—there are thousands of such jobs today many paying even more. New full time jobs and spare time jobs are being created all the time.

"SHOP TRAINING" FOR THE HOME

R-T-I Training is different. It comes to you right out of the factories where Radio sets and other vacuum-tube devices are made. It was planned and prepared and is supervised by radio engineers IN these factories—by men appointed for the purpose. R-T-I will train you as the Radio Industry wants you trained.



BIG MONEY IN AUTO AND POLICE RADIO WORK

W. H. Carr, 402 N. 16th St., Kansas City, Kans. R-T-I student has charge of 35 radio equipped Police cars. He gets \$230.00 a month and free auto, gas, oil, etc. He says: "If I had not taken your course I would not be able to hold this job."



MAKES \$600 IN ONE MONTH

Herbert B. Thomson, Gorman, Texas started making money with 12 lessons finished. He says: "Because of my R-T-I Training I made \$450 in September and over \$600 in October, 1935. It pays to be R-T-I Trained."

TELEVISION, PHOTO ELECTRIC CELLS, PUBLIC ADDRESS SYSTEMS INCLUDED

Radio service work is plentiful but it's only the starting point in R-T-I Training. From there you'll go through the whole field of Radio and Electronics. You will learn about every new development, including Television so you'll be ready when Television breaks.

4 WORKING OUTFITS FURNISHED

Start almost at once doing part time radio work. I furnish 4 outfits of apparatus that you build into test equipment with which you can do actual jobs and earn extra money. My training pays its own way, and you get your money back if not satisfied. Age or lack of experience is no handicap.

FREE BOOK

Find out why R-T-I Trained men get "Quick Results" and "Big Results." Send for "Radio's Future and Yours" today. It tells about Radio's amazing opportunities. It describes my approved training—what R-T-I students are doing and making. It gives the names of 50 firms who endorse and recommend R-T-I. IT'S FREE.

Ray D. Smith
President Radio and
Television Institute
Dept. 224
2150 Lawrence Ave.,
Chicago

MAIL COUPON FOR FREE BOOK

RAY D. SMITH, President
Radio and Television Institute (R-T-I)
2150 Lawrence Ave., Dept. 224
Chicago, Ill.

Without obligating me, send FREE book about spare-time and full-time Radio opportunities and how I can train for them at home.

Name.....
Address.....
City..... State.....

MAKING A "PERSONAL" SET FOR THE BLIND

(Continued from page 585)

superhet. of the latest type, having an A.C.-D.C. power supply unit. Iron-core coils are used throughout to produce the greatest possible efficiency in a small space. Metal tubes are also employed, for the same reason.

A 6A8 is used as combined first-detector and oscillator. This is followed by a new type metal tube—a 6P7. This tube is a combined pentode and triode which acts as both the I.F. amplifier and the second-detector. By an unusual method of tapping the bias resistor, the single cathode is allowed to supply the correct bias for pentode I.F. amplifier and triode detector. The A.F. tube is a pentode—a 25A6—which is similar to the type 43 having a 25-V. filament.

The rectifier tube is a double cathode tube similar to the 25Z5 glass tube. One cathode is used for plate supply to the tubes while the other supplies the field current for the speaker.

The filter choke in the power supply unit is a special type unit having windings designed to reduce the degree of hum to the lowest possible level. The coil is enclosed in a heavy shield to limit the field surrounding the coil. These precautions were taken because the set is to be used with phones and even a low hum level becomes annoying after a time when you are wearing headphones.

Condenser C20 prevents annoying clicks, etc. (due to electric light switches being snapped off and on, etc.), on headphone reception; reverse the line plug for least hum.

An adjustable tone control, C14, consisting of a group of small fixed condensers and a switch, all in one bakelite case mounted on the side of the cabinet, takes the place of the usual resistor and condenser. This serves the double purpose of blocking condenser for the phones and tone control. This hookup of the phones permits the use of Rochelle salt "crystal" headphones.

THE CONSTRUCTION

The layout of the parts can be seen from the photos. It is not essential to follow the layout exactly, though any wide change might cause circuit oscillation or hum and it is advisable, therefore, to follow the layout as nearly as possible.

The circuit is straightforward and should cause the amateur set builder or Service Man little trouble.

When the wiring is finished and the set is ready for adjustment, turn the tuning switch to the position for normal tuning and adjust the trimmers on R.F. and I.F. coils as well as the padder of the oscillator over the entire broadcast band.

Finally, adjust the double pre-set (Ca to Ce) condensers for the various local stations desired, moving the station-selector switch, Sw.3, to the correct position for each station as desired.

(Additional details concerning "pre-set" condensers are contained in the article, "Making the Lazyman '4' Receiver," October, 1935, *Radio-Craft*.)

LIST OF PARTS

- *One set of polyiron coils, antenna (1501) oscillator (2000) and trap coil (R4561), L1, L2 and L3;
- *Two polyiron 465 kc. I.F. transformers, (types C101m and C200m) IFT1 and IFT2;
- One Wholesale Radio 2-gang, 365 mmf. variable condenser, C1 and C2;
- One Solar (TQD) dual 70 mmf. trimmer Ca;
- One Solar (TQD) dual 100 mmf. trimmer Cb;
- One Solar (TQD) dual 140 mmf. trimmer Cc;
- One Solar (TQD) dual 220 mmf. trimmer Cd;
- One Solar (TQD) dual 400 mmf. trimmer Ce;
- *One dial (with special braille numerals for blind section, and kc. scale for visual tuning);
- One IRC 150 ohm, 1 W. resistor, R2;
- One IRC 10,000 ohm, 1/2-W. resistor, R3;
- One IRC 300 ohm, 1 W. resistor, R4;
- One IRC 2,000 ohm, 1 W. resistor, R5;
- One IRC 625 ohm, 1 W. resistor, R6;
- One IRC 20,000 ohm, 1 W. resistor, R7;
- One Blan 178 ohm line cord resistor, R8;
- One IRC 0.1-meg. 1 W. resistor, R9;
- One IRC 0.5-meg. 1 W. resistor, R10;
- One Centralab 25,000 ohm volume control, with line switch, (No. 4 taper) R1 and Sw.1;
- One Centralab 2 circuit, 6 position switch, Sw.3;
- One Aerovox or Cornell-Dubilier .002-mf. condenser, C3;
- Seven Aerovox or Cornell-Dubilier 0.1-mf. condensers, C4, C5, C7, C8, C9, C15 and C21;

- One Solar 400 mmf. padder, C6;
- One 4 mf. Aerovox or Cornell-Dubilier 50 V. electrolytic condenser, C10;
- One Aerovox or Cornell-Dubilier 250 mmf. condenser, C11;
- Three Aerovox or Cornell-Dubilier .01-mf. condensers, C12, C19, C20;
- One Aerovox or Cornell-Dubilier 10 mf. 50 V. electrolytic condensers, C13;
- *One tone control, C14;
- One Aerovox or Cornell-Dubilier 8 mf., 200 V. paper condenser, C16;
- Two Aerovox or Cornell-Dubilier 8 mf., 200 V. electrolytic condensers, C17, C18;
- One Wright-DeCoster 8 in. dynamic speaker with 2,000 ohm field, and transformer for type 25A6 tube;
- One Alloy Transformer Co. 150 ohm filter choke in a heavy alloy case, Ch.1;
- Four Eby octal sockets;
- Two Hammarlund 85 mhy. R.F. chokes, R.F.C.1 and R.F.C.2;
- One Blan aluminum chassis, 16 x 6 1/2 x 2 in. high;
- One Blan shorting-type phone tip-jack unit, J1, J2;
- One Blan snap-switch, Sw.2;
- *One coronet 6A8 tube, V1;
- *One coronet 6P7 tube, V2;
- *One coronet 25A6 tube, V3;
- *One coronet 25Z6 tube, V4;
- One cabinet, and miscellaneous wire, screws, etc. (*Names of manufacturers sent upon receipt of a stamped, addressed envelope.)

OPERATING NOTES

(Continued from page 596)

bypass. The leads to the screen-grid were clipped, the screen-grid tied together and bypassed with a .5-mf. tubular condenser and no further trouble was experienced. This condenser has been found defective in several of these sets.

Kennedy 4 A.C.-D.C. The receiver cut out and was very noisy. A thorough check of the chassis revealed all components to be OK. Finally, each tube was jigged in its socket, whereupon the trouble was localized in the socket of the 6B7 tube. A loose connection was found at the plate terminal of the socket. This was resoldered and the receiver gave no further trouble.
STANLEY STOLBA

A.C. Dayton "Navigator"—Unusual Tube Fault. One of the most baffling cases we have ever had was an A.C. Dayton, Navigator. This set had excellent selectivity but hardly any volume. The voltages and current measurements were normal and no defective parts could be found in the circuit. The owner had mentioned something about "special tubes," and this led us to investigate as to what kind of tubes the set had originally used. Sure enough, the set had come equipped with Speed tubes, which have a very high mu. The repair was effected by replacing all of the 27-type tubes in the set with 56-type tubes, after which the set had plenty of volume.
EUGENE KINGREY

Echophone (No model number visible). The complaint was, terrific noise, while tuning and at times weak reception, more noticeable on deep tones. (Note: the line switch is on the tone control.)

An analyzer test disclosed nothing at first but when reception "blocked" and the tone control shaft became hot it showed a defective tone control condenser, with resultant lack of plate voltage.

Bending plates out of tuning condenser cleared up the tuning noise. They had been touching in certain positions.

Lyric Model D. The owner complained of rising and falling volume. Also, turning on a light in the house would cause volume to be deafening. Oscillation was sometimes apparent.

An analyzer test disclosed correct voltages, tubes tested OK, also substituting new ones gave no different reception.

The remedy was a new volume control. Also added .25-mf. to screen-grid and cathode bypass units which cures oscillation in all these models.

Philco Model 20. The set made a noise like an express train. An analyzer test gave no indication of incorrect voltages. All units and tubes tested OK but a new volume control made reception normal.
DAVIS RADIO SERVICE,
Portage La Prairie, Man., Canada

Now—a high-powered—



Radio Engineering Library

—especially selected by radio specialists of McGraw-Hill publications

—to give most complete, dependable coverage of facts needed by all whose fields are grounded on radio fundamentals

—available at a special price and terms.

These books cover circuit phenomena, tube theory, networks, measurements, and other subjects—give specialized treatment of all fields of practical design and application. They are books of recognized position in the literature—books you will refer to and be referred to often. If you are practical designer, researcher or engineer in any field based on radio, you want these books for the help they give in hundreds of problems throughout the whole field of radio engineering.

5 volumes, 2961 pages, 2000 illustrations

1. Everitt's COMMUNICATION ENGINEERING
2. Terman's RADIO ENGINEERING
3. Chaffee's THEORY OF THERMIONIC VACUUM TUBES
4. Hund's HIGH FREQUENCY MEASUREMENTS
5. Henney's RADIO ENGINEERING HANDBOOK

10 days' examination. Special price. Monthly payments. \$26.00 worth of books cost you only \$23.50 under this offer. Add these standard works to your library now; pay small monthly installments, while you use the books.

SEND THIS ON-APPROVAL COUPON

McGraw-Hill Book Co., Inc.
330 W. 42nd St., New York, N. Y.

Send me Radio Engineering Library, 5 vols., for 10 days' examination on approval. In 10 days I will send \$2.50, plus few cents postage, and \$3.00 monthly till \$23.50 is paid, or return books postpaid. (We pay postage on orders accompanied by remittance of first installment.)

Name.....
Address.....
City and State.....
Position.....
Company..... RC-4-36

Service Men JUST CHECK THESE FEATURES! NEW MILLION



- Tube Tester**
- ★Emission Type
 - ★Metal and Glass Tubes
 - ★Neon Short Test
 - ★0-10-50-500V D. C. at 1000 ohms per V.
 - ★0-5000 ohms
 - ★0-1-10-100 M. A.
 - ★0-2 megohms
 - ★.01 to 3.0 microfarad
 - ★Line Voltage Adjustment and Test
 - ★3" x 7" x 10" overall
 - ★Weight 7 pounds

RADIO AND TELEVISION LABORATORIES
367-99 WEST SUPERIOR STREET, CHICAGO, ILL.

LE'S Correspondence Courses in RADIO and ELECTRICAL ENGINEERING

ELECTRICAL ENGINEERING covers complete electrical field. Most modern course. So simplified anyone can grasp quickly. LOW COST!
RADIO ENGINEERING Ultra-modern course in radio, public address, photo-electric work. Trains you to be super-service man, real vacuum tube technician. Diploma given. Tuition only \$25, either course. Deferred payment plan.

WRITE TODAY for free copies of school catalogs, student magazines, etc. SEND NOW!
LINCOLN ENGINEERING SCHOOL
859-F So. 37th St., Lincoln, Nebr.

SHORT-CUTS IN RADIO

(Continued from page 601)

than trying to count the turns after the winding is completed.

HENRY C. MATTINGLY.

HONORABLE MENTION

CHEAP RELAY. Having need for a photo-cell relay and having a lack of cash (!), the unit in Fig. 10 was rigged up. It is made from the filament relay of a discarded Philco "B" eliminator. The original winding was removed and the bobbin wound full of No. 32 enameled wire. This relay will operate on very low current.

W. R. MCELMURRAY

HONORABLE MENTION

DIAL REPAIR. Certain types of vernier dials of the traveling-pointer type developed annoying slippage after they have been in use for a time. The dial disc wears thin, as may be seen in Fig. 11. The repair is made by taking the shaft out and tapping it lightly with a hammer to close the groove slightly.

E. E. YOUNGKIN

HONORABLE MENTION

BAR KNOBS. Many radio experimenters have old, obsolete radio dials in the junk box. These may be converted into bar knobs by cutting off the sides with a hacksaw. The operation is shown in Fig. 12.

GEORGE M. SHRIVER

HOW TO MAKE A "MAGIC EYE" OUTPUT INDICATOR

(Continued from page 587)

A standard-size flashlight lens and focusing shell is used over the 6E5 tube shield to enlarge the image. This is not strictly necessary, but it does help prevent accidental breakage of the tube dome.

APPLICATION AND USES

Due to the high input resistance of the 6B7, and because of the blocking condenser used on the HI tip-jack, the shielded lead, when plugged into the HI side, can then be attached anywhere from antenna to loudspeaker.

Starting from the antenna, with the shielded lead clips from antenna to ground, very little decrease of shadow is noted—the same result is noted from grid to ground on the first R.F. tube—but from grid to chassis, and from plate to "B plus" of the following stages there should be a progressive decrease in shadow width as the amplification of the receiver increases, stage by stage.

Putting a D.C. voltage, fluctuating or otherwise, on the grid of the 6B7, will cause that voltage to be amplified, and when applied to the diode plates will flow through unchanged (since you cannot rectify D.C.). Therefore, a fluctuating D.C. voltage will cause a fluctuating shadow width. It is very interesting to watch the shadow follow the variations in audio voltage. It is obvious that with 2 of these units connected to input and output stages of a receiver, many useful tests can be performed. For instance, a crackling A.F. transformer with a defective secondary, would cause the shadow of unit No. 2 to jerk open and shut while unit No. 1, connected across the primary would remain steady. If the primary, only, should happen to be defective, both units would show a jerky shadow.

The underside of the indicator chassis.

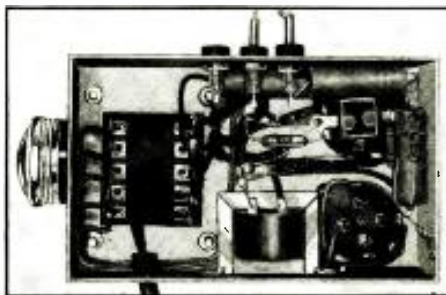

LIST OF PARTS

- One chassis, drilled, black crystalline finish;
- One Stancor power transformer, 600 V. C.T., 6.3V., 5.V.;
- One Stancor filter choke;
- One Aerovox 4 mf. condenser;
- Two tube shields with bases, for dome-type tubes;
- Three Eby wafer sockets, 1—4-prong, 1—6-prong, 1—small 7-prong;
- Three Eby insulated tip-jacks (1—Black, 1—Red, 1—Green);
- One 36-in. shielded lead, with clips and phone tips;
- Four Aerovox 0.1-mf. bypass condensers;
- Two Aerovox mica condensers, 1—100 mmf. and 1—500 mmf.;
- One Aerovox 5-meg., 1/2 W. carbon resistor;
- One Aerovox 1.5-meg., 1/2 W. carbon resistor;
- One Aerovox 1-meg., 1/2 W. carbon resistor;
- Three Aerovox 0.5-meg., 1/2 W. carbon resistor;
- One Aerovox .25-meg., 1/2 W. carbon resistor;
- One Aerovox 300-ohm, 1/2 W. carbon resistor;
- One 5 ft. rubber-covered A.C. line cord with cap;
- One roll hookup wire;
- One RCA-Radiotron, Sylvania, or National Union 6E5 tube;
- One RCA-Radiotron, Sylvania, or National Union 6B7 tube;
- One RCA-Radiotron, Sylvania, or National Union 80 tube;
- One standard-size flashlight lens and holder.

OPENING DOORS AUTOMATICALLY

(Continued from page 589)

CIRCUIT ARRANGEMENT

The electrical circuit operates directly from the regular 60-cycle lighting line (see Fig. 1). The transformer, A, converts 110-120 V. lighting power to 440 V. Since the load on the secondary of this transformer is extremely light, well under 1.W., it does not require a very high power rating. In fact, transformers like those in radio receiving sets may be used (so long as the voltage requirements are satisfactory).

Choke coil B should have a fairly high inductance, say of the order of 100 hy. The maximum current drawn through this portion of the circuit is extremely low and for that reason, a current-carrying capacity of 1 ma. will be ample. If more convenient, this inductance may be replaced by a fixed condenser with a capacity of 0.1-mf.

The adjustable resistance, C, should have a maximum value in the order of 20,000 to 50,000 ohms. Screen-grid resistor D should have a resistance of 50 to 100 megs.

The photo-tube at E is an SR-50 type. A cardboard or metal tube, approximately 2 ins. in dia. and from 8 to 12 ins. long, may be mounted vertically below the sensitive cathode of the photo-tube, which rests in a horizontal position in the control box. Directed so as to pick up the reflection of the headlight beam, such a tube will tend to prevent operation of the photo-tube by extraneous light from one side or the other.

The heart of the device (F, Fig. 1) is a type KU-618 grid-glow tube of the cold-cathode type. It has no filament, and operates by breakdown or ionization of the neon gas within.

When there is no light falling on the photo-tube, the grid-glow tube passes no current except for a few microamperes (between the shield and cathode); the amount of this current is limited by the 10-meg. resistor, G. As soon as light falls on the SK-50 photo-tube, the grid voltage is increased and current passes between the anode and cathode.

This current passes through relay winding H; this winding should have a resistance of between 200 and 1,000 ohms. The relay may be of the D.C., "telephone" or other similar type. With some types of relays, it may be desirable to place a small condenser of 0.1-mf. or larger, across this winding to prevent chattering. The contacts of the relay will in turn close the circuit through the bell-ringing transformer, I, and energize the winding of the door-opener indicated at J.

Our Information Bureau will gladly supply manufacturers names and addresses of any items mentioned in Radio-Craft. Please enclose stamped and self-addressed return envelope.

TAPERS OF MODERN VARIABLE RESISTORS

(Continued from page 593)

er is connected standardized upon 6 variable resistance tapers as suited to any probable radio need. About a year ago, however, curve No. 5 was omitted as unnecessary, and curve No. 7 was added. These curves are shown in Fig. 1.

Resistance tapers 1, 2 and 4 are illustrated with the low end of the taper at the right side of the chart, because they are intended for circuit locations where smooth resistance change from the right terminal is most important, and are tested from that end in manufacture. Curves 3, 6, and 7 are commonly used in circuits where smooth resistance change from the left end is most important, and are therefore tested from the left terminal.

Figure 2 illustrates the 18 basic circuits that are commonly used for volume or tone control.

Taper 1 has uniform resistance change from either end. It has a uniform load characteristic dissipating 1 W. through the total resistance, 1/2-W. through half the total resistance, etc. It is the safest taper to use when in doubt since fair control may be obtained with it in almost every circuit, although the taper properly designated will give better control. Commonly used in circuits 4, 5, and 15.

Taper 2 has slow resistance change at maximum volume. The rate of change progressively increases as the knob is rotated counter-clockwise. This is sometimes termed a *reverse log* taper. Principally used as a series rheostat in the cathode or plate circuit where the current carried may be heavy at maximum volume but very small at minimum volume. Recommended for circuits Nos. 4, 8, or 9.

Taper 3 has very slow resistance change from the left or minimum volume end with a smooth change from the right end. This taper was especially developed for the many small receivers using a single potentiometer to control both the antenna and "C-bias" circuits. Use where the control changes the bias of 1 or 2 tubes with the maximum resistance not exceeding 25,000 ohms. Do not use when controlling the bias of more than 2 tubes or with heavy bleeder current, for this taper may then be overloaded and eventually burn out. Taper 3 may be used in circuits Nos. 1, 3, or 6.

Taper 4 has slow resistance change from the right or maximum volume end with a short taper from the left end. Like curve 3, it is intended for antenna—"C-bias" circuits. With the same overall resistance as taper 3, taper 4 will carry much more current in the "C"-bias circuit because of the more gradual resistance change from the right end. Use where "C-bias" change gives the principal volume-control effect. Commonly used in circuits Nos. 7, 8, or 9.

Taper 6 is a *semi-log* curve with slow resistance change from the left or minimum volume end. Used as an antenna shunt, as a tone control, and as a volume level control in the A.F. control-grid or in most A.V.C. circuits. Recommended for circuits Nos. 1, 2, 3, 10, 11, 12, 13, 16, 17, and 18.

Taper 7 is a true *log* curve providing straight line attenuation over a range of 60 decibels. It is a very expensive taper to manufacture.

Many of the newer sets have a taper volume control to provide some measure of tone compensation. In nearly every instance, these are tapered similar to curve No. 6 with the tap located at approx. 10 per cent of the max. resistance.

This article has been prepared from data supplied by courtesy of Centralab.

DISTORTION IN RESISTANCE-COUPLED AMPLIFIERS

(Continued from page 598)

can be noted by comparing curves B and C, and curves D and E. To aid in interpreting results for practical applications, curves B, C, D and E of Fig. 2 are re-plotted in Fig. 3 as functions of R (indicated as B' C' D' and E', respectively).

For purposes of illustration the triode section of a type 6Q7 tube was used but it is obvious that the principles apply to all tubes of this general class with this type of output coupling.

This article has been prepared from data supplied by courtesy of Hygrade Sylvania Corp.

These Splendid Books FREE!

Think of it! 2 books full of invaluable information, to be had for just the mailing costs! One with 20 complete transmitter designs including 12 tested transmitter RF section designs and 8 modulator and speech amplifier designs. Circuits, complete parts specifications, inductances, etc. all included.

Ten complete designs for public address amplifiers in the other book. It includes one for every purpose, from 3 Watts to 30 Watts output, with complete parts lists for each.

These books should be in every amateur's technical library. They are invaluable for reference purposes. Just 22 cents in stamps, to cover postage, brings them both to you, or get them from any Standard Distributor. Send for your copies today.



STANDARD TRANSFORMER CORP.

856 Blackhawk Street,

Chicago, Illinois

MAIL THIS COUPON!

STANDARD TRANSFORMER CORPORATION,
Dept. C, 856 Blackhawk Street, Chicago, Ill.
I am enclosing 12c for Transmitter Manual.
I am enclosing 10c for Amplifier Manual.

Name _____ Address _____
City _____ State _____

TRY SPRAGUES... and note the difference

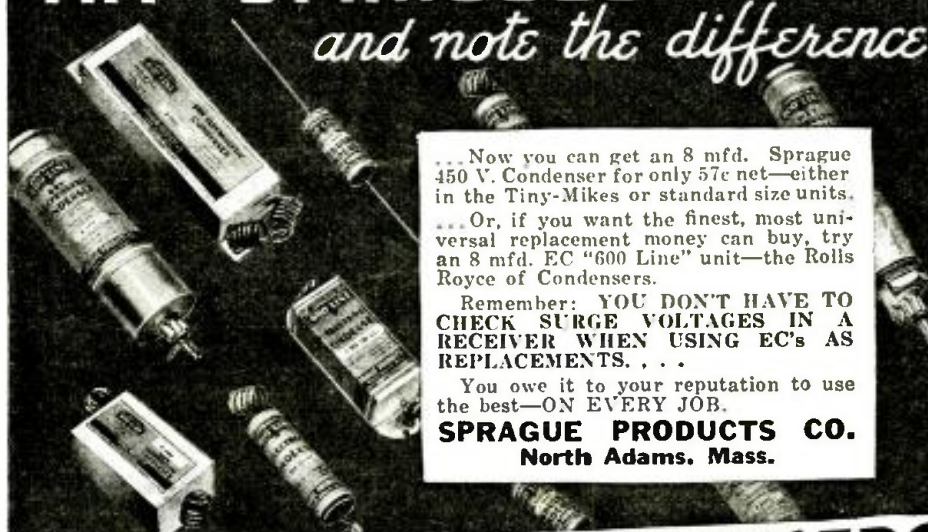

... Now you can get an 8 mfd. Sprague 450 V. Condenser for only 57c net—either in the Tiny-Mikes or standard size units.
... Or, if you want the finest, most universal replacement money can buy, try an 8 mfd. EC "600 Line" unit—the Rolls Royce of Condensers.

Remember: YOU DON'T HAVE TO CHECK SURGE VOLTAGES IN A RECEIVER WHEN USING EC'S AS REPLACEMENTS. . . .

You owe it to your reputation to use the best—ON EVERY JOB.

SPRAGUE PRODUCTS CO.
North Adams, Mass.

SPRAGUE 600 LINE CONDENSERS

AMERICA'S FINEST LINE OF QUALITY UNITS

SERVICE MEN

New, handy Pocket Tool Case keeps your tools together in a convenient place. Fits in your hip pocket or fastens on your belt. Saves wear and tear on pockets. Have your tools ready when you need them. High grade genuine leather case, double sewed, snap flap. Use it at your jobbers. If he cannot supply you write us. Illustrated circular of Radio Service Aids FREE on request.

GENERAL CEMENT MFG. CO.
(Radio Division) Rockford, Illinois

SAVE \$\$\$ on RADIOS

BUY DIRECT 30 day trial
Buy at factory price. 30 models in choice from AC-DC, All-wave, Farm, Car and Metal Tube models. Send postcard for NEW 1936 Bargain Catalog FREE. Get details of 30 day TRIAL plan and Agent-User proposition. Also ask for our NEW Parts Catalog.

ZEPHYR RADIO CO.
11702 Livernois, Detroit, Mich. DEPT. 223

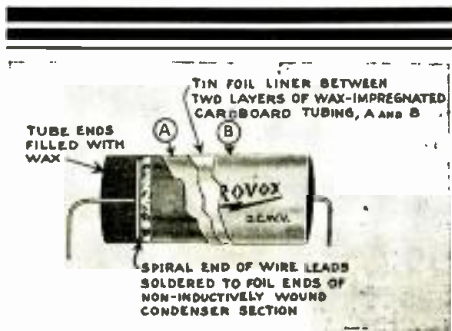

Metal-Sealed TUBULARS

In addition to a thoroughly impregnated section and wax-sealed ends, these units have an imbedded metal-foil wrapping to keep out moisture. Truly triple-sealed. Most dependable. Longest life. Note these features:

- Thoroughly impregnated paper section.
- Wax-impregnated cardboard tubing.
- Tube ends filled with wax.
- Truly triple-sealed. Dampness cannot penetrate.
- Metal-foil liner in cardboard tubing.
- Longer life. Better service.

DATA Send for new 1936 Catalog covering complete AEROVOX line of condensers and resistors. Also sample copy of monthly Research Worker.



Train Now for New RADIO Opportunities

Get Into a Line Where There's Action—Every Day—And a Payday Every Week—You Be the Boss!

Right now while hundreds are looking for work where there isn't any, the radio service field can use trained men. With the proper training and the necessary equipment, you can enter this field and make a comfortable living. We include with our course this modern set analyzer and trouble shooter without any extra charge. This piece of equipment has proved to be a valuable help to our members. After a brief period of training you can take the set analyzer out on service calls and really compete with "old timers." We show you how to wire shortwave receivers—analyze and repair all types of radio sets—and many other profitable jobs can be yours. Teaching you this interesting work is our business and we have provided ourselves with every facility to help you learn quickly yet thoroughly. If you possess average intelligence and the desire to make real progress on your own merits, you will be interested.

Analyzer & Resistance Tester—Latest Design—YOURS Without Extra Cost

ACT NOW — MAIL COUPON

Start this very minute! Send for full details of our plan and free booklet that explains how easily you can now cash in on radio quickly. Don't put it off! Write today. **SEND NOW!**

RADIO TRAINING ASSN. of AMERICA
Dept. RC-64, 4525 Ravenswood Ave., Chicago, Ill.

Gentlemen: Send me details of your Enrollment Plan and information on how to learn to make real money in radio quick.

Name.....
Address.....
City.....State.....

ELECTRONIC MUSIC FUNDAMENTALS

(Continued from page 592)

sented to the public over coast-to-coast radio broadcasts and abroad, for 6 months, beginning on April 6, 1935.

The following is a brief description of diagrams of various simplified methods for the production of tones electrically:

Interrupter-type Tone Wheel. Figure 1A illustrates the simplest method for the production of tones electrically—without amplification. The pitch of the tone depends upon the number of revolutions and the number of segments on the commutator passing a contact brush per second. The quality of the sound from the speaker is rich in harmonics, but is usually marred by brush noises.

Generator-type Tone Wheel. Figure 1B shows a simplified method of tone production in the form of a generating unit consisting of a toothed iron wheel which is made to rotate in front of a magnet with a coil. A minute alternating current having approximately the energy output of an electrical phonograph pickup, originates in the coil and is fed to a matching transformer and thence into the grid of an amplifier, for conversion into sound energy at the loudspeaker or reproducer.

"Electric Eye" Tone Disc. Figure 1C represents a simplified photoelectric tone generator employing a 6V. auto lamp and a motion picture photo-cell. This arrangement is different from those shown in Figs. 1A and B, since the keying circuit from the battery to the lamp has no influence on the sound.

Tone Film. In Fig. 1D, the upper section illustrates a well-known method of electrical tone production, using sound film as a medium, as used in the motion picture practice. Film A is made to move uniformly upward (or downward) and light from the filament of the lamp is focused in the form of a light slit onto the sound track, which has translucent repeating patterns.

The lower section of Fig. 1D illustrates the Eremeeff method of tone production. Film B is stationary, and readjustable at desired intervals, in front of the photo-cell.

Figure 2 represents a keyboard with 2 diagrams for comparison. The upper diagram shows frequency ranges of various voices and conventional musical instruments, compared with the tones of a good organ.

The lower portion illustrates methods for synthesizing fundamental frequencies with their partials and sub-partials at predetermined variable intensities. This method of synthesis (artificial production) is used in electronic organs and is impossible for adaptation to pipe organs, since change in intensity results in change of pitch of the partials of the fundamentals, produced by "couplers," used in the pipe-organ practice. (For further information, see "Electromagnetic Music," last paragraph, *Radio-Craft*, November, 1932.)

Figure 1E shows a complete but simplified diagram of a synthetic musical tone-generator for producing one fundamental and two harmonics, each of which is adjustable in its intensity by selected taps to the secondary of a transformer. The operation is similar to that of Fig. 1C.

MODERNIZING THE SET ANALYZER

(Continued from page 600)

AVAILABLE RANGES

The A.C. voltage ranges available are 0-4, 0-8, 0-16, 0-160, and 0-800 V.

The D.C. voltage ranges available are 0-5, 0-10, 0-100, 0-500, and 0-1,000 V.; direct current ranges are: 0-10, 0-100, and 0-500 ma.

Three direct-reading ohmmeter ranges are provided on the D.C. meter, namely, a "low range"—0-3,000 ohms; "medium range"—0-¼ meg., and "high ohms"—0-2½ megs.

LIST OF PARTS

- One etched-metal panel;
- Two "Precision" etched-metal scale plates;
- One 9-wire analyzer cable, plug and adapters;
- One 4-deck, 12-contact rotary switch—"RANGE SELECTOR";
- Two 2-deck, 12-contact rotary switches—"POSITIVE and NEGATIVE SELECTORS";
- One 2-deck, 10-contact switch, special type—"CURRENT SWITCH";
- One dual poten.—0-2,000 ohms.—0-6,500 ohms—"ADJUST OHMS";
- One S.P.D.T. toggle switch—A.C.-D.C. switch;
- One D.P.S.T. pushbutton switch—"READ METER";
- One D.P.D.T. pushbutton switch—"REVERSE METER";
- One 0.5-mf. condenser;
- One resistor to increase the millivolt drop of the D.C. meter to 250 mv. (to complete with shunt values)—M1;
- One kit of D.C. multipliers—M2-4.750; M3-5,000; M4-90,000 ohms; M5-4-meg.; M6-5-meg.; M7-3,000; M8-40,000; A.C. multipliers—M9-8 V.; M10-16 V.; M11-M12-160 V.; M13-800 V.; shunts—S1-25; S2-2.224; S3-0.555 ohms;
- One carrying case, sockets, pin jacks, terminal strips, etc.

This article has been prepared from data supplied by courtesy of Precision Apparatus Corp.

The circuit of the modernized set analyzer.

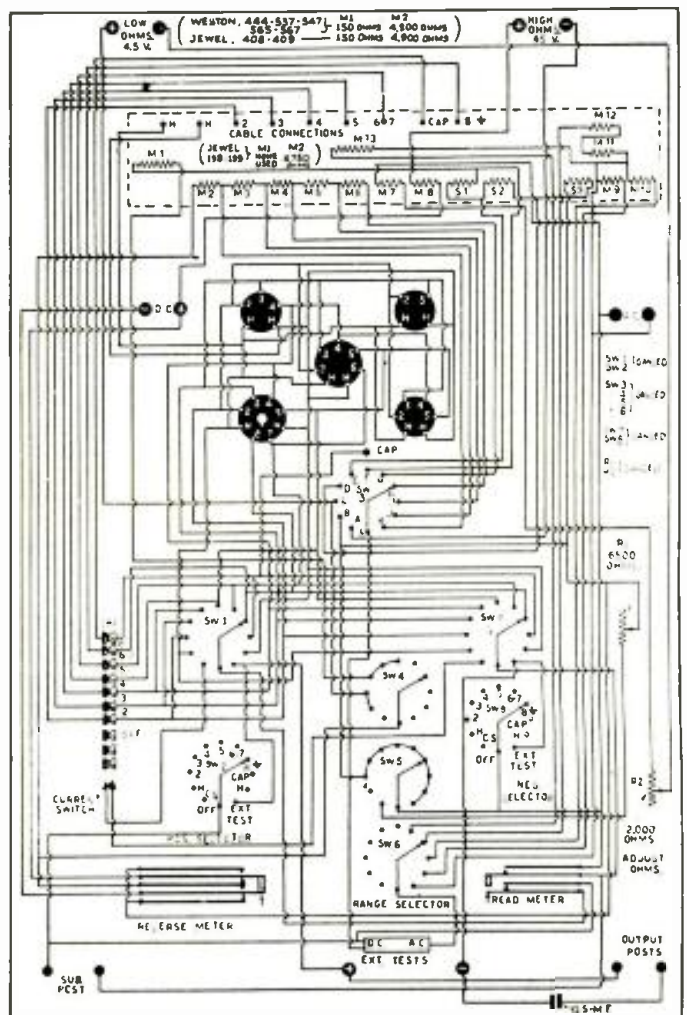

MAKING A COMPACT RESISTANCE-CAPACITY TESTER

(Continued from page 593)

output of a "B" power supply. By means of Sw. 1, any desired value may be fed to the positive test lead pin-jack via Sw. 2 and Sw. 4, through the resistor under test to the negative pin-jack; through Sw. 2 again to a suitable resistance box for balancing-out purposes; back through Sw. 4, through meter No. 1; through Sw. 4, through Sw. 2 to the negative leg of the power supply.

The voltage drop is measured on meter No. 2 which connects to a D.P.D.T. toggle switch (Sw. 3). Meter No. 2 measures either the applied potential or voltage drop.

Meter No. 1 connects to a 4-pole, 4-throw, 3-position key switch (Sw. 4) and is used as an ohmmeter (when used in conjunction with a resistance box), with Sw.2 and Sw.4 thrown to position 1. When Sw.4 is in position 2, meter No. 1 is cut in the circuit as a milliammeter for breakdown test; Sw.2 in position 2 for breakdown test. Meter No. 1 showing the current through resistor under test and meter No. 2 the voltage drop. By applying Ohm's Law, the watts rating (or higher) may be applied to the resistor. Placing Sw.4 in position 1 also shorts the positive leg through to the positive pin-jack, while in position 2 it shorts the negative leg from the resistance box to the negative supply lead when meter No. 1 is used as a milliammeter. This simplifies the operation and does away with 2 extra shorting switches.

To use the unit as an ohmmeter, Sw.2 and Sw.4 are placed in position 1. Switch Sw.1 is set on 5 V. with 5,000 ohms cut in on the resistance box to give the standard-scale ohmmeter (that is, from 100 ohms to 0.1-meg.). The remaining values are multiples—that is, the 10 V. with 10,000 ohms will read double the resistance of the above range. The 100 V. with 0.1-meg. will read 20 times the resistance of standard range, etc. When Sw.5 is closed we have the old familiar "shunt" method; that is, the test lead pin-jacks come directly from the meter; the potential and resistance are in series across the meter; meter reads full scale. This range covers from 1/4-ohm to 100 ohms.

Figure 1A. First let us find the value in ohms a resistor is high or low. Say the value is 15,000 ohms; with Sw.1 set on 25 V.; Sw.2 thrown to position 2; Sw.4 to position 1; and Sw.3 to applied potential. Noting values involve 25 V. of applied potential, resistor under test is 15,000 ohms. Since meter No. 1 is a 1,000 ohms-per-volt meter, 10,000 ohms addition resistance is required for full-scale deflection. This is cut in on the resistance box. Now close line Sw. of the power supply unit and note the deflection on meter No. 2; adjust this to exactly 25 V. using the line adjuster. Now note meter No. 1 deflection. Since it is known that the resistors of the resistance box are correct, if the 15,000 ohm unit is correct in value full-scale deflection is obtained. The amount of resistance cut in is the value in ohms that the resistor is low.

If meter No. 1 reads less than full-scale deflection, the 15,000 ohm resistor is high in value and it is simply necessary to cut out resistance from the box until the meter reads full-scale. The amount cut out will be the value in ohms that the resistance is high.

To give the resistor a voltage drop and breakdown test, refer to Fig. 1C. When switches are thrown to respective position, you have this hookup. The procedure is then as follows:

First connect a pair of test leads across the terminals of the resistor. It is 15,000 ohms with a 1-W. rating. Set Sw.1 to 300 V.; Sw.2 to position 2; Sw.3 to the applied potential; Sw.4 to position 2. Now cut in 285,000 ohms resistance on the resistance box. Close the line switch and adjust the applied potential to exactly 300 V. on meter No. 2. Now flip Sw.3 to Voltage Drop. Meter No. 2 should read approximately 15 V.

To apply a breakdown test simply begin to cut out resistance on resistance box. The current in meter No. 1 will begin to increase as will the voltage drop on meter 2 and by simply applying Ohm's Law, $W=EI$ and noting the readings of meter No. 1 and No. 2 the watts being dissipated through the resistor as resistance is cut out may be determined.

The same procedure used for resistors can be used for transformer windings and choke coils. A transformer winding of 3,000 ohms D.C. resistance will show a 3 V. drop on the 10 V.

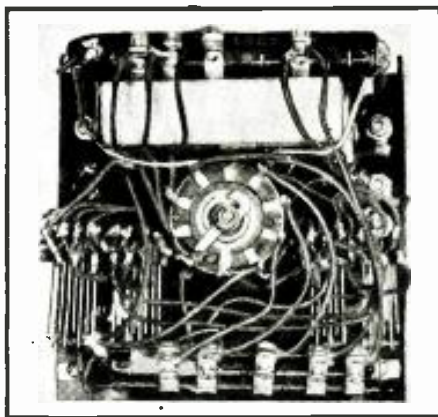

Under-panel view of the test unit.

scale of meter No. 2, while a choke coil of 400 ohms D.C. resistance will show a voltage drop of 0.4-V. on the 1 V. scale of the meter.

REQUIREMENTS IN SERVICING 16 MM. TALKIES

(Continued from page 600)

average radio man can easily acquire a working knowledge are: (A) types of sound tracks; (B) function of the exciter lamp; (C) theory and operating functions of the photo-cell.

TYPES OF RECORDING

There are 2 types of recording in general use at the present time: (1) *constant width—variable density* (more commonly known as "Western Electric") recording, which consists of shaded lines that vary in thickness (see A, Fig. 2); and (2) *variable width—constant density* ("Photophone") recording, which, when inspected, seems to be a facsimile of an oscilloscope curve (see B, Fig. 2).

In either type of recording, a definite, narrow beam of light, created by an intense light from an "exciter lamp" is passed through an optical lens arrangement in the soundhead (see Fig. 1).

16 MM. ADJUSTMENT CONSIDERATIONS

The exciter lamp must be properly placed in its socket so that full illumination is obtained from it. The correct position of this lamp is to have the filament of the lamp parallel to the sound gate or aperture plate of the soundhead. It is important that the light-beam from the lens tube be horizontal where it strikes the opening of the sound aperture.

To install the photo-cell it is important to know which is the *anode* (or *positive*) contact and the *cathode* (or *negative*) contact of the cell. This can be checked by looking at the photo-cell itself. The thin red wire running vertically through the center of the photo-cell is the *positive* or *anode* element; while the plate directly back of the wire rod is the *cathode* or *negative* element.

There are several points of radical difference between 16 mm. and 35 mm. prints that may not be apparent at first glance to the layman. The 16 mm. in use for sound-on-film has only one set of sprocket holes (Fig. 2C), and these are centered on line with frame lines one perforation at each line. The sound track replaces the other set of sprocket holes and is .065-in. wide as compared to .071 for the 35 mm. film. This allows for practically as great a volume level at 100 per cent modulation using the variable width—constant density method of recording as is obtained on the professional recordings on 35 mm.

The 16 mm. traveling at 36 ft. per minute as compared to 90 ft. per minute for the 35 mm. has caused practically the same complications with tone fidelity as in 33 1/2 r.p.m. recordings, when compared to 78. In the case of film, trouble was encountered in recording the high frequencies due to cramping in the linear path. However, 4,500 cycles is the present cutoff for 16 mm. which is near the cutoff for radio sets other than the latest wide-range sets capable of reproducing to 7,500 cycles. The present top-register for 35 mm. film is 9,000 in standard equipment, with an increase to about 12,000 cycles expected shortly.

This article has been prepared from data supplied by courtesy of S.O.S. Corp.



- MODEL 554-A
READRITE'S BEST
PRICE ONLY
\$14.40
- AT THESE PRICES
- Model 430 Tube Tester\$18.00
 - Model 710-A Set Tester\$16.50
 - Model 720-A Point-to-Point Tester \$15.00
- All prices are dealer's net.

MODEL 554-A NEW READRITE ALL-WAVE SIGNAL GENERATOR

1. Uses Plug-in Coils.
2. Five Coils supplied covers range from 100-20,000 kc.
3. Uses 2 #30 tubes for perfect attenuation.
4. Calibration Curves supplied with each instrument.
5. Complete with tubes, batteries and other necessary accessories.

If you want a real surprise in performance, try this Signal Generator. Compare it point for point with any Signal Generator, regardless of price.

Other Readrite Products

Readrite manufactures all types of testers used for servicing radio sets, including: Oscillators, Set Testers, Tube Testers, Resistance, Continuity and Capacity Testers, Point-to-Point Testers and inexpensive Indicating Meters.



MAIL COUPON NOW!

READRITE METER WORKS
416 College St., Bluffton, Ohio

I am interested in.....

Please send me your new 1936 Catalogue

Name

Address

City State.....

Please Say That You Saw It in RADIO-CRAFT

GREAT PLANS AHEAD FOR NATIONAL UNION RADIO SPECIALISTS! TIE UP NOW!

QUALITY MERCHANDISE

FREE INSTRUMENTS

BUSINESS BUILDERS

CHARTS · DATA

GET DETAILS NOW!

NATIONAL UNION RADIO CORP. of N. Y.
 570 Lexington Avenue, New York, N. Y.

Send circular telling me what I can get from National Union and where!

Name _____

Street _____

City _____ State _____

METAL TUBES

Have Not Made Obsolete

THE SHALLCROSS UNIVERSAL TESTER

Liberal allowance made on your obsolete meters and instruments.

RANGES:

Volts A.C.-D.C.
 5-25-100-250-1000
 1000 ohms per volt

Milliamperes D.C.
 1-10-100-1000

Capacity
 .001-10 Mfd.
 Paper or electrolytic condensers.

Inductance
 1-10,000 Henrys

D.C. Resistance
 .5-5,000,000 ohms.

Send full description of old instrument you wish to trade-in and 6c in stamps for Bulletin 611-PE describing the Shallcross Universal Tester.

SHALLCROSS MFG. COMPANY
 Electrical Measuring Instruments and Accurate Resistors
 700 MAC DADD BOULEVARD
 COLLINGDALE, PA.

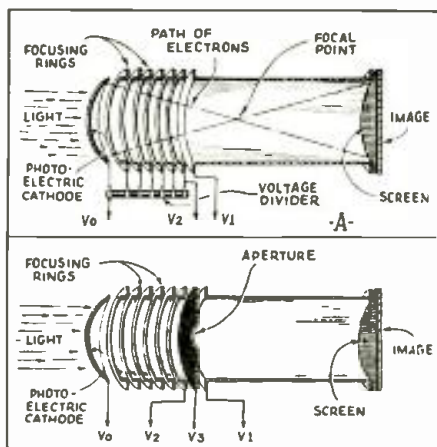

Fig. 1. Two forms of image tubes are shown in cross-section.

THE ELECTRON IMAGE TUBE

(Continued from page 594)

were thus reflected back from the layer (which was always a dense mass having a heavy metallic coating on the inside of the glass wall of the tube, thus making it quite opaque).

Later research has shown that a microscopic layer of platinum sputtered on the glass or quartz plate is sufficient for the conducting layer and a thin layer of oxidized silver reacted with caesium vapor, forms an efficient photo-sensitive layer.

This type of cathode is translucent and, in fact, may be actually transparent—yet it acts as an efficient photo-sensitive surface. With this type of photo-sensitive layer, a light beam impinging from the rear, through the glass or quartz plate will throw a stream of electrons from the sensitive layer as a continuation of the light beam, instead of reflecting them in the old manner.

It is this type of photo-sensitive layer that Dr. Zworykin uses for the cathode of his tube. Referring again to Fig. 1A, the tube contains a dome-shaped cathode, a series of ring-shaped anodes (which we will mention later), and a fluorescent screen at the opposite end of the tube. The electrons emitted as a result of light striking the semi-transparent cathode move in more or less straight lines, so that the image is reversed, just as it would be in a terrestrial telescope of ordinary design; Fig. 1A shows why this is so.

The electrons emitted by the photo-sensitive cathode will not all move in a straight line from the surface of the layer, due to irregularities in the layer's surface, etc. However, if we place a metal cylinder in the tube in front of the cathode, and connect this cylinder to a source of high voltage, the electrons will be forced to follow straight paths. By cutting the cylinder into individual narrow rings and applying gradually increasing voltages to these rings (giving to the ring nearest to the cathode the lowest voltage) an increasing effect of concentrating the electrons toward a central or focal point will be obtained. Thus the electrons are not only made to follow straight lines, but the lines are forced to gradually converge. The electrons leaving the edge of the dome-shaped cathode are affected much more than those near the center and those which are exactly at the center are not affected at all, since the forces affecting them are equal and opposite.

Thus, the electrons leaving the top of the cathode are bent down and strike the bot-

tom of the fluorescent screen, while those from the bottom reach the top of the screen. This results in a reversal of the image and accomplishes the desired focusing.

Now by introducing an additional ring in the tube in the form of a plate with a circular opening (or aperture) at the center, and connecting this plate to a source of voltage different from the rings, any stray electrons will be prevented from reaching the fluorescent screen and the effect of the rings (or "focusing anodes", as Dr. Zworykin calls them) will be increased. (See Fig. 1B.) This causes an increase or decrease in the magnifying power of the image tube over the fixed-focus type. (Fig. 1A.)

FOCUSING THE TUBE

In any optical instrument, it is important to have some means for adjusting the focus. This cannot be done by moving the electrodes, when the tube has been sealed off, so the "effective position" of the focusing anodes and aperture plate are adjusted by varying the potentials applied to these electrodes.

Thus, by varying the potential on the aperture plate, the position of the "lens" is shifted, which has the dual effect of enlarging or reducing the size of the image and changing the focus so that the focal length set by the annular anodes can be adjusted to bring an image in or out of focus with the fluorescent image screen.

The complete tube—as shown in the illustrations—contains a voltage divider within, to properly distribute the potentials to the focusing rings. This leaves the overall potential on the annular rings, the potential on the aperture plate and the potential on the cylinder surrounding the remainder of the tube's length available for adjustment. Although voltages of about 1,200 are needed for the image tube, the power supply unit is quite compact since the current flow is very low, being used only for P.E. current and leakage.

PRACTICAL RESULTS

In the demonstration of the tube, before the American Association for the Advancement of Science, the assembled scientists witnessed the projection of motion pictures focused on the tube which converted light rays into electrons. The electrons sped through the tube and reproduced the pictures in enlarged form on the screen. (The degree of magnification varied between 1/2 and 3 times by adjusting the focusing potentials.) Continuing the demonstration, a dark glass filter was placed in the beam of the motion picture projector being used in the demonstration. All visible light rays were stopped dead, yet the electron image tube continued to reproduce the enlarged pictures with hardly any noticeable loss in clarity! Figure E shows the reproduction of a cartoon reproduced with infra-red light as described above.

The demonstration also included a display of the effect of spherical aberration when a flat cathode was used and the correction obtained with the dome-shaped cathode. Figures F and G show the image of a grid when reproduced with both tubes.

In the above description, an attempt was made to describe in as simple language as possible the results and method used in the Zworykin image tube. The reader will find that a knowledge of optics as described in any physics text book will help in understanding the action and the similarity between optical lenses and the newly-developed electronic lenses.

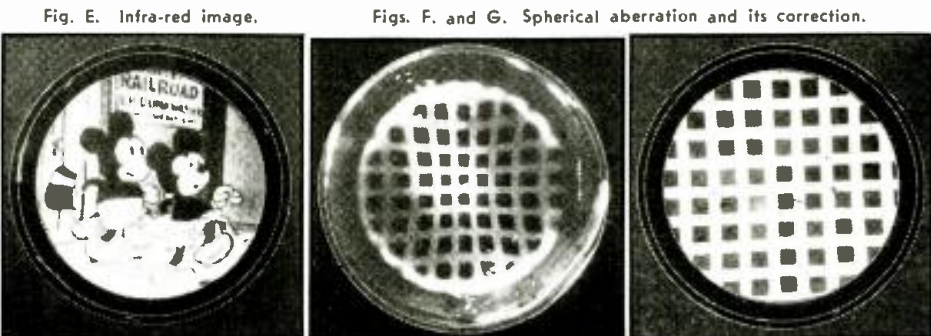

Fig. E. Infra-red image.

Figs. F. and G. Spherical aberration and its correction.

HOW TO MAKE A BEGINNERS 2-TUBE PORTABLE

(Continued from page 605)

phase of the receiver's construction may be modified to suit the constructor, since it is not, by any means, the best method of construction and is not at all critical with regard to the efficiency of the set. The coils, however, should be mounted as shown, and not too close to the sides of the case since the grounded sides will then tend to absorb energy from the coils and reduce their efficiency.

The controls for operation of the receiver are all mounted on one end of the case, which constitutes the upper side; this is the side which protrudes from the pocket so that the controls are easily accessible and may be manipulated at will. The controls consist of: (a) the switch—for turning the filaments "on" or "off"; (b) the volume control, which permits adjusting the sensitivity of the receiver; and (c) the tuning control, which actuates the 2-gang variable condenser.

CIRCUIT DISCUSSION

In order to secure maximum possible sensitivity and selectivity from 2 tubes it was decided to employ 2 tuned circuits. One stage to consist of T.R.F. amplification, the other to be a tuned detector circuit. The type 34 tube would have been satisfactory were it not for its physical dimensions. Hence, the use of a 1A4 and a 1A6.

In the wiring diagram it will be noted that the 1A4 is employed as the R.F. stage. The pentode section of the 1A6 is employed as the detector, while the triode section is used for A.F. amplification. The gain (amplification) from this section, although very slight, is quite acceptable. In addition, there is an electron-coupling effect (due to the construction of this tube—placement of the various grids) between its 2 sections (pentode and triode). Consequently, any R.F. component which may exist in the plate of the detector tube is fed back, by electron-coupling, to the grid of the detector tube. In this manner regeneration is created, which serves to boost the sensitivity of the receiver.

Since the voltage of two flashlight cells in series results in 3 V., and the tubes require only 2 V., an 8-ohm resistor is employed for reducing the initial voltage to the required value. The gain (amplification, or sensitivity) of the R.F. stage is controlled by a 200-ohm potentiometer which connects across the 3 V. supplied by the cells. The "on-off" switch is connected in series, before the potentiometer, to prevent any constant current from flowing through this resistance, especially when the power is turned "off."

LIST OF PARTS

- One I.C.A. midget variable condenser, 350 mmf. each section;
 - *One midget antenna coil (shield removed);
 - *One midget R.F. coil (shield removed);
 - One I.C.A. aluminum case, 7 $\frac{3}{4}$ x4x2 $\frac{3}{4}$ ins. deep;
 - One power switch;
 - *One midget 200-ohm potentiometer;
 - One wire-wound 8-ohm resistor;
 - One Aerovox or I.R.C. 5,000-ohm 1-W. resistor;
 - One Aerovox or I.R.C. 3,000-ohm 1-W. resistor;
 - One Aerovox or I.R.C. .25-meg. $\frac{1}{4}$ -W. resistor;
 - One Aerovox or I.R.C. 0.1-meg. $\frac{1}{2}$ -W. resistor;
 - One Aerovox or I.R.C. 2-meg. $\frac{1}{4}$ -W. resistor;
 - One Cornell-Dubilier .01-mf. 200-V. tubular condenser;
 - One Cornell-Dubilier .05-mf. 200-V. tubular condenser;
 - Two Cornell-Dubilier 0.1-mf. 200-V. tubular condensers;
 - Two Cornell-Dubilier 250-mmf. fixed mica condensers;
 - One 6-prong wafer socket;
 - One 4-prong wafer socket;
 - One I.C.A. 5-terminal bakelite strip;
 - Two No. 935 dry-cells;
 - One Sylvania 1A4 tube;
 - One Sylvania 1A6 tube;
 - Miscellaneous parts, such as aluminum scrap for shelving and brackets; knobs, etc.
- *Name and address of manufacturer will be furnished upon receipt of a stamped and self-addressed envelope.



MR. E. H. RIETZKE
President, CREI



... There's A Future Now For Men Who Train!

This story from IRSM NEWS clearly shows that there is a good future for good men in the Radio Service field. New equipment and new trends demand that YOU keep pace by training and studying, because among radio servicemen it is going to be "the survival of the fittest."

"Service and Public Address Engineering"

PRACTICAL RIGHT FROM THE START

Written for experienced servicemen and covering every important subject. You can do more jobs and make more money after the first few lessons.

WRITE FOR FREE BOOKLET

This new CREI course is an "insurance policy" on your future. Things are changing fast in Radio. The good servicemen today, might be the "ham" tomorrow! Radio needs good men and you need training to hold down the job you're expected to do. CREI can help you as we have helped others—let us tell you how.

CAPITOL RADIO ENGINEERING INSTITUTE

14th and Park Road, N. W., Dept RC-4, Washington, D. C.



Tey

OXFORD SPEAKERS!

A wide line of finest quality instruments, moderately priced. There is a size and type for every RADIO, PUBLIC ADDRESS and THEATER purpose. See your Jobber or write us regarding type of equipment you need.

WRITE US "ATTENTION DEPT. C"



OXFORD-TARTAK RADIO CORP.
350 W. Huron St. Chicago, Illinois

SEND FOR THIS

FREE

CATALOG

Check full of BARGAINS in RADIO SETS, Long and Short Wave Apparatus, Servicemen's Repair and Replacement Parts, Electrical Appliances and hundreds of Miscellaneous Specials at TREMENDOUS SAVINGS. Get this big new Bargain Book. It's absolutely FREE without obligation—just send us your Name and address on a post card.

RADIO CIRCULAR CO., INC.
915 Broadway, Dept. R. C., New York, N. Y.



Bargain Bulletin



LATEST ISSUE Just Out

Now Ready!

The "SUPER-PRO"

Amateur-Professional Receiver

THE finest receiver ever to bear the Hammarlund name—the receiver that outperforms all preceding standards of sensitivity, selectivity and tone.

Write Dept. RC-4 for Complete Details

HAMMARLUND MANUFACTURING CO.
424-438 W. 33rd St., New York.



For Better Radio
Hammarlund
PRECISION PRODUCTS

Build-It-Yourself

A Short Checker for Metal Tubes Made with Insulated Continental Carbon Resistors



Send this ad and \$1.00 to any jobber listing CONTINENTAL Carbon resistors and the parts illustrated will be sent with Bulletin 104 containing complete instructions, postpaid in U. S. A.

CONTINENTAL CARBON Inc.

13914 LORAIN AVE. CLEVELAND, OHIO

Servicemen!



A BETTER SERVICE BUSINESS FOR YOU!

Chances are ten to one that YOUR business CAN be made better, more efficient, MORE PROFITABLE.

... You CAN get better jobs.
... You CAN expand to do all types of work quicker and easier.
You CAN learn to merchandise your business to greater advantage.

Enthusiastic letters from many Sprayberry graduates offer convincing proof. I have helped them on the road to success—and perhaps I can help you. Certainly, as a serviceman, you owe it to your business future to mail the coupon today and GET THE FACTS about Sprayberry's Practical Mechanics of Radio Service. This will place you under no obligation—and it may be the turning point in your business career. You have nothing to lose—much to gain.

F. L. SPRAYBERRY, 2548 University Pl., N. W., Washington, D. C.

Without cost or obligation, please send your book "PUTTING PROFITS AND EFFICIENCY INTO SERVING."

Name _____

Street _____

Address _____ RC4/36

**SPRAYBERRY'S PRACTICAL
MECHANICS OF RADIO SERVICE**

EQUIPMENT FOR THE SERVICE MAN

(Continued from page 595)

forth their ideas is evidenced by the fact that most of the letters must have taken the contestants at least 8 or 10 hours to prepare!

After the winners of the contest had been decided and the judges were through with the letters, the writers decided to carry the contest material a step further in order that the readers of *Radio-Craft* might obtain some practical benefits from it. Accordingly they carefully examined every one of the letters again and tabulated the essential ideas expressed in them.

List of Essential Equipment Recommended For The "Ideal Radio Service Shop"

1. Set Analyzer
2. Tube Checkers (2)
3. Test Oscillator and Output Meter
4. Grid-Dip Oscillator (optional)
5. Cathode-Ray Oscilloscope and Frequency Wobbler
6. Vacuum-Tube Voltmeter
7. Ohmmeter
8. Wheatstone Bridge
9. Condenser Analyzer and Tester
10. Substitution Condenser Units or "Indicator"
11. Substitution Resistor Units or "Indicator"
12. Decibel Meter (optional)
13. Magnetic-type Test Reproducer
14. "Universal"-type Dynamic Reproducer
15. Test Tuner with own Power Supply (for Substitution)
16. Test Turntable. Phone. Pickup, Records and Amplifier Unit
17. Test Power Supply Unit
18. Wattmeter (0-100-200-500-1,000W.)
19. Portable Battery-Operated Interference Locator (optional)
20. Those shops which do auto-radio work require a Vibrator Tester, and both 6 V. and High-voltage Power Supplies.
21. Those shops which service battery-operated receivers require a 6-V. Storage Battery with Trickle Charger, at least 135 V. of "B" Batteries, and 22½ V. of "C" Batteries.
22. Those shops which do P.A. work require the usual Sound Truck fully-equipped for portable work.

DETAILED SPECIFICATIONS OF INSTRUMENTS

(A) Portable Set Analyzer: For portable use, the volt-ohm-milliammeter, used together with a socket selector unit of the plug-in type is demanded by most Service-Men.

1. The outfit must make regular voltage-current socket analyses, and point-to-point (or "free reference") voltage and resistance tests (see section for recommended meter ranges).
2. Most Service-Men seem to prefer the use of selector switches rather than pin-jack systems. However, those few who expressed a preference for the use of pin-jack terminals and jumpers on the panels gave good arguments in favor of this arrangement, claiming that:
 - (a) Switches and switch troubles are thereby eliminated.
 - (b) The panels and test instruments are simplified considerably as regards the wiring.
 - (c) A more flexible, low-cost system is provided, and confusion is reduced.

3. The single-meter type instrument *calibrated directly* seems to be preferred. Fan-type meters are desired. In some cases, there is a preference for separate meters for A.C. and D.C. measurements.
4. The analyzer should incorporate facilities for tube checking, and power output level tests.
5. Provision should be made for inserting headphones in the circuits to audibly test R.F. detector or A.F. stages for noise, etc.
6. The control-grid cable should be effectively shielded to prevent oscillation and consequent change of readings. A neon tube oscillation indicator is helpful for checking this condition.

(B) Shop Set Analyzer: For shop use, the analyzer should have at least 2 or more meters, mounted either on the panel or in the unit (in the case of a rack-and-panel assembly). Fan-type meters at least 5-in.-large are desirable—especially when they have multiple scales. (See also Test Panel and Test Bench).

(C) Meter Ranges Desired

- (a) D.C. Milliampers: 0-5-10-25-50-100-250-500.
- (b) A.C. Milliampers: 500 maximum (detailed ranges not quoted).
- (c) D.C. Amperes: 0-1-5-10-25.
- (d) A.C. Amperes: 0-1-5-10.
- (e) D.C. Volts: 0-5-10-50-150-300-500-1,000 (1,000 ohms-per-volt, or higher).
- (f) A.C. Volts: 0-5-10-50-150-300-500-1,000-1,500 (1,000 ohms-per-volt, or higher).
- (g) Ohms: Most of the Service Men stressed the necessity for a range such that low values down to 1₁-ohm may be accurately measured. The other ranges should be: 0-50-100-1,000-10,000-0.1 meg.-1 meg.-10 megs.-30 megs. Scales should be marked clearly to avoid confusion. The ohmmeters are desirable in combination with voltmeters of low range, or are combined as volt-ohm-milliammeters.

(D) Tube Checker: Most of the Service Men desire to have tube checkers which are so designed that they will not become obsolete when new tubes are brought out. There should be sufficient sockets on them to make adapters unnecessary, but the use of too many sockets should be avoided. There should be as few controls as possible and the tubes should receive their actual rated voltages when tested (both plate and filament). Tests should be accurate regardless of the line voltage, and some reliable form of line voltage check and compensation should be included. The checker should test for:

- (a) shorts between elements (hot cathode).
- (b) leakage between elements. This test should be very sensitive—especially for short-wave tubes. A neon-tube indicator for leakage is preferred.
- (c) gas.
- (d) noise.
- (e) worth of tube.

The mutual-conductance type of test is preferred by most for service use, with an emission test applied to diodes and rectifiers. Some suggest provisions for plugging phones into the circuit for audibly detecting noisy tubes. Facilities for testing all the grid sections of multi-grid tubes are stressed. The English-reading type of tester is preferred for counter use. For field use, opinion is divided between the English-reading and the numerically-calibrated scale type of instrument.

(E) Service Oscillator: Most Service Men desire A.C. line operation with self-contained power pack. Others need both A.C. and D.C. line operation. Those in rural districts prefer battery operation with all batteries self-contained.

The R.F. range most preferred is from 100 kc. to about 30 mc. This provides facilities for testing I.F. amplifiers directly, also. All signals should be *fundamentals* only, and scale should be accurately calibrated and clearly marked.

The oscillator should be well shielded and provide a calibrated attenuation adjustment from at least ½-V. to ½-microvolt. The importance of being able to secure extremely low output for aligning sensitive sets below the A.V.C. point is stressed.

Practically all prefer provisions for cutting in modulation at will (which should be variable). The majority prefer external modulation by the following methods (in the order of their preference):

- (a) by a calibrated, variable 20- to 15,000-cycle A.F. oscillator which may also be used for testing A.F. amplifiers, reproducers, etc.
- (b) by a single 4,000-cycle note.
- (c) by a microphone or phonograph pickup.

(F) Grid-Dip Oscillator: An all-wave, grid-dip type oscillator is generally considered valuable for indicating circuit resonance when matching tuning coils, checking shorted coils, detecting defective padding condensers and other effects in the oscillating circuit.

(G) Cathode-Ray Oscilloscope and Frequency Wobbler: The consensus of opinion is that most of the oscilloscopes now on the market do not give a sufficiently well defined image, are insufficiently sensitive for use in aligning all receivers encountered, and need a larger screen (at least 5 ins. in diameter). The following suggestions have been put forth for consideration:

- (a) a frequency wobbler having a 12 kc. "low" sweep range and a 20 kc. "high" sweep range.
- (b) a 15-6,000 cycle sweep circuit generator.
- (c) an A.F. harmonic filter for distortion analysis.
- (d) calibrated removable transparent scale

MODERNIZE YOUR RADIO

WITH THE MYSTIC EYE TUNING UNIT



Perfect Tuning with the New Cathode Ray Tube.

Can be easily installed on all sets using A.V.C. with 2½ v. or 6 v. tubes.

Completely wired with the standard Cathode Ray Tube 24" of 5 wire cable, one MEG resistor panel escutcheon and mounting screws, and special bracket.

List Price . . . \$3.00
Regular discounts apply.

See it at your jobber, or write to

EMPIRE RADIO CORP.
1217 Washington Blvd. Chicago, Ill.

7-TUBE SUPER KIT

Kit Includes: ANTENNA COIL; R.F. COIL; OSCILLATOR COIL; 1st I.F. COIL; 2nd I.F. COIL; 3-GANG TUNING CONDENSER. Price . . . \$1.95

Schematic circuit diagram for A. C. and Auto Receiver furnished.



T.R.F. KIT

ANTENNA COIL; 2 R.F. COIL; 3-GANG DEJUR TUNING CONDENSER. Price \$1.25

Write for our special circular radio parts and tubes.
Send enough money for parcel post or we ship by express collect.

ARROW SALES CORPORATION
631 Washington Blvd., Chicago, Illinois

CLASSIFIED ADVERTISEMENTS

Advertisements in this section are inserted at the cost of twelve cents per word for each insertion—name, initials and address each count as one word. Cash should accompany all classified advertisements unless placed by a recognized advertising agency. No less than ten words are accepted. Advertising for the May, 1936, issue should be received not later than March 5, 1936.

A.C. AUTO GENERATORS

TURN SCRAP INTO MONEY. AUTOPOWER SHOWS you how easily and economically auto generators can be converted into A. C. or D. C. generators and D. C. motors, 2 to 1000 volts; for sound, radio, power, light, or welding. No previous experience necessary—complete information all in new book, with simple instructions and illustrations. Endorsed by thousands. Only \$1.00 postpaid. Autopower, Inc., 414-C S. Hoyne Ave., Chicago.

RADIO

RADIO ENGINEERING, BROADCASTING, AVIATION and police radio, servicing. Marine and Morse Telegraph taught thoroughly. All expenses low. Catalog free. Dodge's Institute, Pine Street, Valparaiso, Indiana. IRON CORE I.F. TRANSFORMERS 175 OR 456 K.C. 85¢ each. United Coil Co., 2220 S. Kedzie, Chicago, Illinois.

NEW! THE LARGEST AND FINEST CATALOG OF THEATRE SOUND EQUIPMENT EVER ISSUED!

FREE ON REQUEST

Hundreds of new items, valuable charts, data, etc., amazing money-making BARGAINS TO SELL!
S. O. S. CORP. 1600 B'way, N. Y. C. cable "SoSound"

Send today for your copy of new 16-page booklet crammed full of valuable and vital information on

"AERIALS AND HOW TO USE THEM"

Contains diagrams and complete information for eliminating noise on all bands, improving foreign reception, use of antenna couplers, balanced line filters, ultra high frequency transmission and reception, ham operation, and multiple installations for apartment houses and store demonstration hook-ups.

Sent postpaid for a dime

Arthur H. Lynch, Inc., Dept. R, 227 Fulton St., N.Y.C.

screens for reading R.F. selectivity, impedance, inductance, reactance, capacity, current and voltage.

(e) an oscillograph recorder for checking up the receiver output before and after alignment.

(f) that the oscilloscope and signal generator be built together for convenience.

(H) Vacuum-Tube Voltmeter: Almost every Service Man has expressed the need for a V.-T. voltmeter. A line-operated instrument seems to be preferable. Ranges covering 1 microvolt to 1 V. and 0-5-50-100-1,000 V. r.m.s., and 0-500-1,000 V. peak are desired. The meter should be direct-reading and easily portable.

(I) Wheatstone-Bridge: There seems to be a popular demand for a combination bridge provided with a battery and oscillator to accurately measure resistance, capacity, inductance and impedance. Directly-calibrated dials to read in henries, mf. and ohms are desirable.

(J) Condenser Analyzer and Tester: A very urgent demand exists for a single condenser analyzer and tester which not only will measure the capacity of the condenser by means of a bridge circuit, but which also, by means of a neon-tube arrangement will check the leakage, and detect "shorts" and "opens." A power supply should be incorporated for applying the rated peak voltage to the condenser under test. The capacity test should cover ranges from .00001-mf. (10 mmf.) to about 16 (or 20) mf.

(K) Substitution Condensers: The use of a substitution condenser bank arranged in the form of a "decade" box is very popular. Selection should be by means of rotary switches. A range from .00001-mf. to 16 (or 20) mf. is desirable.

(L) Substitution Resistors: The use of substitution resistors in the form of a "decade" box is preferred by many Service Men to routine ohmmeter testing. A range from 1 ohm to 10 (or 20) megohms is considered desirable. Other Service Men prefer the "continuously variable" type of resistor equipped with a sliding contact.

(M) Test Speakers: A standard magnetic-type reproducer and a universal-type dynamic reproducer (preferably built together in one case) are useful for checking set and reproducer performance. The universal dynamic reproducer should have facilities to match its impedance to all tubes, output transformers and set field combinations.

(N) Test Power Supply Unit: A power supply unit capable of supplying the necessary range of A.C. filament voltages as well as filtered D.C. plate, screen-grid and control-grid voltages for all types of receivers is very useful. A unit which will supply A.C. filament voltages of 1.5, 2.5, 3.5, 5, 6.3, 7.5, 10, 12, 15, 25, and 48 V. (2 A. capacity), and 1,000 V. D.C. (250 ma., maximum) smoothly adjustable to any lower voltages is considered adequate for most shops. A separate 6-V. storage battery and a vibrator-type power supply unit for auto-radio work are also convenient.

(O) Auto-Radio Vibrator Tester: Many Service Men who do auto-radio service work expressed the need for a reliable, inexpensive tester which would check the condition of auto-radio vibrators and the amount of R.F. interference they generate. The tester should preferably operate in conjunction with the usual tube checker.

THE SHOP TEST PANEL

The "rack-and-panel" system of test panel construction seems to be the most popular because of its extreme flexibility as regards both design, future addition of equipment, and changes. Many, especially those who service auto-radio sets, prefer a movable panel mounted on casters. Most of the small- and medium-size shops require a flexible equipment arrangement, such that each test unit may be easily removed and carried out on service calls whenever it becomes necessary.

It is generally conceded that the test bench should be about 36 ins. high, 30 to 36 ins. deep and from 6 to 20 ft. long (the longer the better). The bench should be sturdy and supplied with drawers. A chassis cradle for all types of sets; a pickup magnet magnetizer and transformer flasher; coil winder; small lathe; small grinder; small drill press; small compressor for use as a paint sprayer and "blower" for cleaning out dust from chassis; the usual assortment of tools and spare parts; phones; complete file cabinet for service records, case histories, manufacturers' receiver data, technical magazines and articles, mailing list, etc.

This article has been prepared from data supplied by courtesy of Radio Technical Publishing Co.

"YOUR NEW BOOK SURE HAS THE ANSWERS!"



FREE!

GET YOUR COPY OF SERVICE HINTS TODAY. IT WILL IRON OUT A LOT OF TOUGH SPOTS

● SHORT cut solutions . . . new ways to solve everyday problems . . . questions on circuit and receiver troubles . . . Sylvania's new volume of SERVICE HINTS has all the answers!

That's why it will actually mean money in your pocket to have this handy FREE booklet. Any day you might run into some of the problems outlined in this book . . . and the tips you'll find there may save you hours of trouble shooting on some hard-to-crack job.

Hundreds of successful service men wrote this book . . . sent in their solutions to tough problems they have solved. Sylvania compiled them into this second volume of SERVICE HINTS . . . and it's yours without any charge whatever.

Don't wait. Send today for your copy of SERVICE HINTS, Volume 2. It will put you in line for more and better service jobs. Simply fill out the coupon below . . . and you'll get your copy of Service Hints in a few days.

Hygrade Sylvania Corporation. Makers of Sylvania Radio Tubes and Hygrade Lamps. Factories at Emporium, Pa., Salem, Mass., and St. Mary's Pa.

SYLVANIA

THE SET-TESTED RADIO TUBE

Hygrade Sylvania Corporation
Emporium, Pa.

RC-4

Please send me free, without obligation, Volume 2 of Sylvania's "Service Hints."

Experimenter Amateur Call.....
Serviceman Employed by dealer
Independent

Member Service Organization.....

NAME

ADDRESS

CITY..... STATE.....

NAME OF JOBBER.....

ADDRESS

To Give FACTORY-TYPE SERVICE



RCA Cathode Ray Oscillograph, accurate, scientific, simple to use, impressive to customers. **\$84.50 net, complete**

To make it possible for service men to use the same instrument used in factories for peaking I. F. transformers, checking distortion, etc., we offer the RCA Cathode Ray Oscillograph. Entirely self-contained, including power supplies. With RCA Test Oscillator and RCA Frequency Modulator you can offer complete factory service; or use it as a modulation indicator for your amateur transmitter, etc. See it at your RCA Parts Distributor's.



OSCILLOGRAPH

RCA Parts Division, RCA Mfg. Co., Inc.
Camden, N. J. An RCA Subsidiary



Left: Resistance element baked on Bakelite ring.



Right: Mechanism showing shoe in contact with ring.

Not FRICTION-less but Friction-RIGHT

The very fact that you can feel the contact as you turn the shaft of an Electrad Volume Control is the best sign of its electrical quietness. There are no gaps to cause stuttering or noise.

The single moving part—the contact shoe—moves on a carbon resistance element permanently baked to a warp-and-wobble-proof Bakelite ring. This mechanical simplicity means fewer parts to wear, less chance for trouble.

The more an Electrad is used, the smoother and quieter it gets, because the direct contact is self-polishing and self-cleaning.

Every Electrad Volume Control is noise tested at the factory and is fully guaranteed. Try one on your next service job. Write Dept. RC-4 for a new catalog.



RESISTOR SPECIALISTS

Featuring—Quiet Carbon Volume Controls. Vitreous Resistors, Truvalt Resistors and Power Rheostats.

THE DESIGN OF MODERN TEST EQUIPMENT

(Continued from page 597)

through the coil, the movement can be calibrated in units of current; or in any other units, such as volts, microfarads, ohms, etc., which have a definite relationship to units of current.

Usually, a meter which is calibrated for current measurements in terms of amperes, milli-amperes, and microamperes, has a comparatively low resistance and is connected in series with the circuit in which the current is to be measured; and a potential-measuring meter (or "volt-meter") is of comparatively high resistance and is connected across the circuit at which a potential difference is to be measured.

METER SPECIFICATIONS

The meter shown in Fig. A requires 1 ma. for full-scale deflection, so that it has a sensitivity of 1,000 ohms-per-volt for all D.C. potential measurements. Its accuracy tolerance is 2 per cent of full-scale values. Observational errors are reduced to a minimum by the use of a combination "spade" and "knife edge" type pointer for maximum accuracy and ruggedness.

For current, potential and resistance measurements the meter is "built up" to a resistance of 300 ohms by means of a "multiplier resistor", Rm, wired in series with the meter, as in Fig. 1A, and all shunt and multiplier resistor values are calculated on the basis of a full-scale current "sensitivity" of 1 ma.; and a meter resistance value of 300 ohms. The actual armature resistance of the meter is about 115 ohms, which is more than the usual resistance value of a 1. ma. meter; this higher resistance value is used so as to enable more turns of wire on the armature to provide a greater movement torque. The value of 300 ohms for Rm includes the 115 ohms (about) of the meter armature.

Being fan-shaped it has considerably longer scales, and we shall see how a standard 1. ma. meter, combined with a special impedance circuit will measure D.C., D.C. volts, A.C. volts and capacity on an evenly-divided scale.

CURRENT MEASUREMENTS

To use this meter for current measurements in terms of milliamperes (or "ma."), it is shunted in the manner indicated in Fig. 1B. The total shunt value of 75 ohms is determined by the lowest current-measuring range of 5 ma. The meter with its resistance built up to a value of 300 ohms, requires a potential of 0.3-V. (300 millivolts) to cause a full-scale current of 1. ma. to pass through the meter. The shunt resistor for the 5-ma. range, being in parallel with the meter, will have the same 0.3-V. potential difference. Since 1. ma. of the 5-ma. range will pass through the meter, the shunt resistor will pass the other 4 ma. and its value is determined by dividing 4 ma. (.004-A.) into 300 millivolts (0.3-V.). This division establishes the value of 75 ohms for the total shunt resistance value shown in Fig. 1B.

For the current-measuring ranges above the 5 ma. range, the 75-ohm shunt resistor is divided into smaller values, thereby forming what is known as a "ring type" shunt, the total "ring" resistance value being 375 ohms. The resistance values of the sections of the 75-ohm shunt resistors are determined by multiplying the total "ring" resistance by the full-scale current of the meter, dividing the result by each range value, in turn, from the common terminal, and subtracting the sum of the preceding values from each newly-determined value. When the "ring" value of 375 ohms is multiplied by the full-scale sensitivity value of .001-A., we have a value of .375 into which each range value is divided, in turn, for determining shunt values.

For example, the shunt value for the 1.250-A. range is determined by dividing 1.250 into .375, giving a value of 0.3-ohm for that range. For the 500-ma. range, 0.5-A. is divided into .375, giving a value of .75-ohm for the 500-ma. range; but, since we already have a value of 0.3-ohm for the preceding range, it is necessary to subtract 0.3-ohm from .75-ohm, leaving a value of .45-ohm for the second section.

For the 250-ma. range, .25-A. is divided into .375, giving a value of 1.5 ohms for the 250-ma. range; but, since we already have a value of .75-ohm for the 2 preceding ranges, it is necessary to subtract .75-ohm from 1.5 ohms, leaving a value of .75-ohm for the third section of the shunt. The shunt sections for the other ranges are determined in a similar manner, and we

"Do You Know the Answer?"

How to Go About Looking For
A Job?

How to Better Your Position?

How to Plan Your Career?

The answer to these and many other questions, such as: How to earn money in spare time jobs, what occupation to choose, inside stories of how the other fellow has done it, statistics, facts, will be found in the new monthly magazine

JOBS & CAREERS

For Sale at all Newsstands NOW.

Leading articles by vocational experts, personnel directors, leaders of industry tell you how to tackle your problems and how to increase your chances of success.

IF YOU WANT TO LEARN WHY MOST FELLOWS FAIL, WHERE OTHERS SUCCEED, READ

Jobs & Careers
THE VOCATIONAL DIGEST

On all Newsstands 25c a copy

If your dealer cannot supply you,
send a quarter and we will forward
a copy at once.

JOBS & CAREERS

Dept. RC-4

520 N. Michigan Avenue Chicago, Illinois

Over 130,000 People
Find Each Issue of

EVERYDAY SCIENCE AND MECHANICS of Intense Interest!

EVERYDAY SCIENCE AND MECHANICS is the finest scientific-technical-mechanical constructional magazine in the field. Up-to-the-minute with news flashes of scientific events. Dozens of constructional articles and many popular experiments. Ideas from which you can make things to sell.

A Host of Interesting Subjects Covered:

Woodworking—Photography—Magic—Patents and Inventions—Book Reviews—Metalworking—Chemistry—Engineering—Microscopy—Electrical Experiments—Household Helps—Astronomy—Prize Contests—and other subjects.



10c
THE COPY

ON ALL
NEWSSTANDS

OVER 150 ILLUSTRATIONS

can "check" the accuracy of our calculations by Ohm's Law.

For example, the shunt value of 0.3-ohm for the 1,250-A. (1,250 ma.) range is in parallel with the remaining 374.7 ohms of the "ring" circuit which, when multiplied by the meter current of .001-A., produces a potential drop of .3747-V. With .001-A. going through the meter, the remaining value of 1.249 A. will be going through the 0.3-ohm shunt, producing a potential drop of 0.3 times 1.249 or 0.3747-V. Since the potential drop across both parallel paths is identical by Ohm's Law, it is concluded that the calculations are correct. The other ranges may be similarly "checked" by Ohm's Law.

D.C. POTENTIAL MEASUREMENTS

It is convenient to remember that "potentials" in electrical discussions are somewhat comparable to "pressures" in studies of hydraulics. When a milliammeter is used for measurements of electrical potentials, enough resistance must be connected in series with the milliammeter to limit the current to within the full-scale sensitivity value of the meter. The required resistance is 1,000 ohms-per-volt for a meter which has a full-scale value of 1. ma. In the design of the circuit under discussion, the value of the multiplier resistor for the 5-V. range is established by subtracting the meter resistance value of 300 ohms from the 1,000 ohms-per-volt value of 5,000 ohms, leaving a multiplier resistance value of 4,700 ohms. For the higher ranges, the multiplier resistance values are calculated on the basis of 1,000 ohms-per-volt. The D.C. voltmeter circuit is shown in Fig. 1C.

A.C. POTENTIAL MEASUREMENTS

The A.C. potential-measuring functions of this circuit differ from the D.C. potential-measuring functions in that (1) the meter is connected to the output terminals of a full-wave instrument rectifier, (2) a condenser is substituted for the 4,700-ohm multiplier resistor, and the condenser is connected in series with the rectifier input circuit, and (3) each of the multiplier resistors above the 5-V. range is bypassed with a calibration condenser. The elements involved in the A.C. potential-measuring functions are indicated in Fig. 1D.

A simple vector diagram is illustrated at Fig. 1 E. This is used to determine the impedance, Z, when the resistance, R, and the capacitive reactance, Xc, are known. This calculation is made in connection with the circuit of Fig. 1 D.

Part 2 of this article will continue with directions for correcting for A.C. measurements, determination of current density effect, and its correction, and many other invaluable details.

This article has been prepared from data supplied by courtesy Supreme Instruments Corp.

METAL TUBE "SHORT" AND "OPEN" TESTER

(Continued from page 597)

cathode and heater—terminals 8 and 7—are separated by 8,000 ohms. Most ohmmeters capable of reading 10,000 ohms will plainly distinguish a difference of 500 ohms; thus a leakage of 120,000 ohms shunting with 8,000 ohms will cause that circuit to show a net 7,500 ohms. This degree of sensitivity is adequate for metal tube cathode-to-heater leakage testing.

The 5Z4 tube uses terminals 2 and 8 for its heater circuit. The arrangement of the resistors is such that the 5Z4 tube will give a reading of 2,000 ohms if its heater is intact, and if no internal short-circuits exist.

The polarity indicated at terminals 3 and 8 is recommended so that tubes may be tested while their cathodes are hot. The current applied in the test opposes the natural electronic emission of the cathode, thus avoiding the appearance of leakage which the electrons might ordinarily cause.

Due to fact that the resistor circuit is open until a tube is inserted in the socket, an ohmmeter may be permanently connected when the short tester is mounted in a bench test panel; in a tube tester; or in a portable ohmmeter.

Because of the close proximity of the parts and the possibility of the resistors touching each other, resistors with body and end insulation are most suitable for this circuit.

This article has been prepared from data supplied by courtesy of Continental Carbon, Inc.

"and the price is right!"

Silvertone SUPER-EIGHT
REG. U.S. PAT. OFF
Communication Receiver

Dear Sirs:

I received the new Amateur Super-Eight communication receiver and have given it a very good test and want to say that it is one of the best receivers I have heard and the very best for the price. Anyone wanting a first class receiver for amateur work I can say that the Super-Eight will do all that any other receiver will do and the price is right for the average "ham" of today!

Very truly yours,
Everett T. Smith

All the Latest Features:

- 8 Latest Type Tubes.
- 8 inch Dynamic Speaker.
- 3 Bands 540-18000 Kilocycles.
- Iron Core I. F. Transformers.
- Smooth AVC Action.
- Preselection on all Bands.
- Perfect Band Switching.
- Beat Frequency Oscillator.
- Sensitivity Control.
- Completely assembled in cabinet.



\$49⁹⁵
CASH

Send for FREE Catalog RC653L.

On Easy Payments, \$11.00 Down

SEARS, ROEBUCK and CO., CHICAGO



800 OSCILLOGRAPH

SENSATIONAL APPEARANCE — PERFORMANCE — PRICE

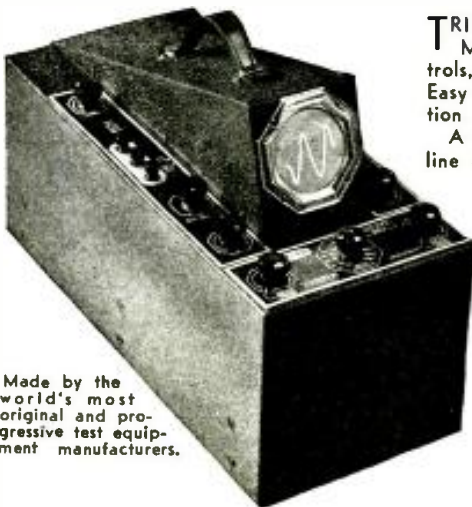

Made by the world's most original and progressive test equipment manufacturers.

TRIUMPH again creates a masterpiece, the new Model 800 OSCILLOGRAPH. All manual controls, connections and Cathode Ray Tube on top. Easy to operate, read and connect. A revelation in design, workmanship and performance.

A worthy new addition to the famous TRIUMPH line of test equipment.

FEATURES

- Perfect Locking
- Perfect Linearity
- Widest Sweep Range
- Horizontal and Vertical Amplification
- Ideal for Photo Analysis
- Graduated Reference Scale
- Power Cut Off Safety Switch
- Top Deck Controls
- Wide Angle View

Price Complete **\$79.50 NET**

Triumph Manufacturing Company
4017 W. Lake St., Chicago, Ill.

Please send me without obligation, brochure on the Model 800 Oscillograph.

Name

Street

City State

Write today for complete information on this remarkable new instrument.

TRIUMPH MANUFACTURING CO.
4017 W. Lake St. Chicago, Ill.

To Readers of RADIO-CRAFT
FREE POST CARDS MAY BE HAD UPON WRITING TO PUBLISHERS

These post cards make it easy to answer advertisements which appear in RADIO-CRAFT, without cutting valuable data which you may wish to save.

Many times manufacturers request you to "clip the coupon" when answering their ads. Often this means destroying part of an article on the reverse page you may need later for reference. Save your RADIO-CRAFT issues complete. If you should ever want to see bound volumes, or certain copies of RADIO-CRAFT, the resale value of uncut issues is very much higher than that of mutilated ones. So send for a supply of these free Post cards and use them in answering all RADIO-CRAFT advertisers.

NEW LOW PRICE
on
AMPERITE
CURRENT AND VOLTAGE
REGULATORS

Amperite replacements for AC-DC sets now LIST \$1.25. Amperite 3-40 can replace AC-DC set regulators 50x3, 500, and 5B. Also new low price on replacements for 2-Volt Battery Sets, List \$1.60

Write for CHART CV.

AMPERITE Co., 561 BROADWAY NEW YORK

FREE



SPRING CATALOG OF
RECENTLY LISTED
RADIO VALUES
FROM 1935 to 1936
1936
WHOLESALE RADIO SERVICE CO.

Right up to the minute! Every last minute price change! Every latest development! All leading manufacturers represented!

You'll find a large selection of Lafayette Public Address Equipment... amplifiers from 3 1/2 to 100 watts for every conceivable occasion, complete systems, portable and mobile, auto radios, aerials, parts and accessories. A big section is devoted to receivers from 4 to 24 tubes.

Remember—NO non-essentials; only fast selling profit-making summer sellers! Get your copy today—Just address Dept. C-46.

EXCLUSIVE HAM CATALOG. Specialized catalog written by amateurs for amateurs—send for it today on your Q.S.L. card. 68 pages crammed with Ham stuff.

NEW LAMB NOISE SILENCER
We carry all the parts for this new development... at lowest WHOLESALE prices.

WHOLESALE RADIO SERVICE CO.
CHICAGO, ILL. • NEW YORK, N.Y. • ATLANTA, GA.
101 W. JACKSON BLVD. • 100 SIXTH AVE. • 418 W. PLEASANT ST. N.W.
BROOKLYN, N.Y. • NEWARK, N.J.
418 CENTRAL AVE.

And the Answer to the demand for a quality Magnetic



is **"Hyflux"** the

- High Efficiency
- Wide Frequency Range
- Permanent Dust Proofing
- Rugged Construction

Write For Complete Details Specifications, Prices

WRIGHT-DECOSTER, Inc.
2251 University Ave. St. Paul, Minn.

Export Dept.: M. Simmons & Son Co.
Cable Address: SIMONTRICE, New York
Canadian Office: Wright-Decoster, Inc.
Guelph, Ont.

THE VERSATILE CATHODE-RAY TUBE

(Continued from page 599)

lograph, some types of which incorporate the cathode-ray tube, in its elementary form of a mechanical contrivance was an actuality even before the existence of the cathode-ray phenomenon was noted. (For further technical details the reader may wish to refer to the 12 articles on cathode-ray technique, by the writer, and others, as published in the last 2 volumes of RADIO-CRAFT.—Author)

USEFUL APPLICATIONS OF THE CATHODE RAY

Since the beam of electrons that comprise the cathode ray is weightless and inertialess it may be moved with the rapidity of light. This instantaneousness of motion permits exact analysis of such ephemeral conditions as the waveform of the human voice, as indicated in Fig. B.

Oscillographic Voice Test. Lily Pons, as she trills high C in an aria from *Care Nome*, is here shown "checking up" the purity and steadiness of the tone, as indicated on an oscilloscope at the G.E. "House of Magic" in New York City; oscillographic records (or "oscillograms") are subsequently studied and analyzed by laboratory scientists, in an effort to perfect all the component devices associated with the transmission and reception of sound.

High-Speed Sound Analyzer. Dr. Harry H. Hall, of Cruft Laboratory, Harvard Univ., has gone many steps further; he has perfected one of the most amazing cathode-ray devices so far to be announced—the *high-speed sound analyzer*, is the name by which technicians know this instrument (illustrated in Fig. C).

This "analyzer" makes a photographic record on paper of the *intensity* and *frequency* of the different components present in sound. The Hall analyzer operates over a frequency range of 50 to 10,000 cycles, which is adequate for checking such audio minutiae as the *accent* of an individual's voice!

Pre-Recording Oscillograph. "Natural static" (lightning) has been compelled to "go formal"—it now must leave its calling card, so to speak, as recently reported to the National Academy of Science, in meeting at the University of Virginia, at which was announced the "oscillograph with a memory," shown in Fig. D.

Dr. A. W. Hull (of the G.E. labs.), discusses this new electronic device as follows:

In recent years engineers have succeeded in developing lightning recorders that would function almost instantaneously—within one-millionth of a second, in fact. But even this astounding speed of action (the "reaction time," it is called) is quite inadequate for determining exactly what occurs a minute fraction of a second before the stroke has built to a particular value. A desirable device then would be one possessing a virtual "memory," or retention of the stroke's appearance just prior to a particular instant. It is this effect which the new instrument accomplishes.

Identically the same operating requirements exist where it is desired to secure photographic record of various unpredictable occurrences in electrical circuits—as for instance in determining the waveform in the current-carrying filament circuit of a vacuum tube at the instant of break-down of the filament.

These conditions are met in the new pre-recording oscillograph in the following manner. The fluorescent screen of the cathode-ray tube has a "time delay" sufficient to permit one or several complete cycles to be viewed on the screen at a given instant. Then, when failure occurs in the cycle-producing mechanism a thyratron-type tube actuates a camera shutter, thus "taking a picture" of the "faulty" cycle, and such preceding portion of it as the screen may have retained. In Fig. E is shown a

Fig. E. An oscillogram of a filament failure.

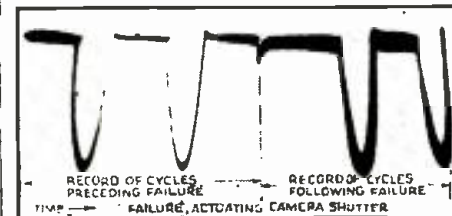

SPRAYER OUTFIT

ELECTRICAL—PORTABLE **\$32.50** Complete with Gun, ready for Service



This is the ideal Outfit for all around spraying work wherever current is available. Sprays everything: Lacquers, Oil, Cold Water Paints, Enamels, Varnish, Insecticides, Disinfectants, Shoe Dress, etc. The Unit is compact, completely self-contained.

Ideal for spraying Furniture, Radiators, Screens, Machinery, and other maintenance paintings in Homes, Schools, Clubs, Hospitals, Stores, Factories, and office Buildings.

The Gun furnished with this Unit is of Pressure Gun type; requires but 2 cu. ft. of Air per minute. Has Bleeder type construction which assures uniform pressure at all times without clogging the Air Passage which is easily cleaned. Furnished with 3 Nozzles which produce Fan, Round, and Right Angle Spray respectively.

Complete Unit consists of Air-cooled Compressor with machined Fan-cooling Pulley, V-Belt Drive; Pressure type Gun with 1 quart Aluminum Paint Cup; 3 Taps; 1/2 H.P., Heavy Duty Motor, 110/120 volt, 60 cycle, AC; 1 1/2 ft. rubber covered 2 1/4" Air Hose; 8 ft. Cord & Plug; Filter Tank; Entire Unit mounted on Base with Ball Bearing Casters.

A low priced Power Sprayer; the kind of Machine that usually sells for \$50.00 to \$60.00.

Price of complete outfit, shipping weight 60 lbs.	\$32.50
Price of outfit complete, less Motor, shipping weight—35 lbs.	\$25.50
Price of Gun only with 3 nozzles, shipping weight, 7 lbs.	\$7.50
Price of Compressor only, shipping weight 15 lbs.	\$9.50

Our Old Customers Know That Our Merchandise Is Sold on a Strict Money-Back Guarantee

All Shipments will be forwarded by Express Collect if not sufficient postage included with your order.

WELLWORTH TRADING CO.

560 W. Washington Bd. Dept. RC-436, Chicago, Ill.

Universal-Type Power Transformer
In Alloy Hum Proof Casting 425-350-0-350-425 V. at 125 m.a. 5VA., 8VA., C.T., and Bl. Shield. Code ALP.T.A. Net price, \$1.50. 30-13,000 cycles ± I.D.B. Multiple Coil, Hum Free Balanced construction. **AUDIO TRANSFORMERS** in Hum Free Castings. Each net. \$3.75. **CHOKE** in Alloy Hum Free Castings, \$1.75.

AALLOY TRANSFORMER CO., Inc., 135R Liberty St., New York City

RADIO SET BUILDERS

AMATEURS - EXPERIMENTERS

DON'T buy radio supplies until you have received our 65 page catalog, checked full of money saving items. Our prices lower than any other mail order catalog.

AREN RADIO, Dept. X
Radio Building, Plane and Market Sts. NEWARK, N.J.

DIALS—SHUNTS

Etched Small
Mod. 301-88-321 5 to 500 M.A.
27-30-50-100 M.V.
From Retail & Wholesale dealers
D. L. VAN Leuven, 410 E. 15 St., N.Y.C.

RADIO ENGINEERING,

broadcasting, aviation and police radio, servicing, marine radio telegraphy and telephony, Morse telegraphy and railway accounting taught thoroughly. Engineering course of nine months' duration equivalent to three years of college radio work. All expenses low. Catalog free. School established 1873.
Dodge's Institute, Hudson St., Valparaiso, Ind.

FREE

IMPORTANT ILLUSTRATED BUYING GUIDE FOR RADIO EXPERIMENTERS. SERVICE MEN, AND SHORT-WAVE FANS. 32 Pages—Two Colors—Profusely Illustrated. This Book Will Save You Money!

Packed between the covers of this 32-page book is a tremendous array of modern radio equipment and other electrical and scientific merchandise—the very material for which you have been looking—and at prices which cannot possibly be any lower.

Radio sets and parts, low priced microphones, automobile radio sets, complete public address equipment, field glasses, the finest short-wave equipment available, crystal receivers, radio replacement parts, etc., etc. Name the item—and it's in the book! This amazing book will show you how—and it's in the book! You save by buying at the lowest possible prices. Why not start saving now? Don't delay! Write today! Send postcard or letter. Book by return mail. It's free!

RADIO TRADING COMPANY
97 Hudson Street, New York N. Y.

- - a new magazine for short-wave fans!
SHORT WAVE LISTENER



4,600 Short-Wave stations listed

THE finest magazine of its kind ever published—initially different in set-up and contents from any other. Contains the latest listing of short-wave stations in the world, up-to-the-minute, including "Police," "Television" and short-wave stations, as well as an special list of the star short-wave stations with their frequencies and call letters. Also contains photos and descriptions of short-wave broadcasting stations in various parts of the world with photos of short-wave studio artists—How to locate "weak" distance stations, and other hints for the "short-wave listener"—Question and Answer Department for the "Listener"—Silver Cup Trophy for best photo of listening "Posts."

15c the Copy • **ON ALL NEWSSTANDS**
SHORT WAVE LISTENER 99 Hudson St. New York, N. Y.

BUILD IT YOURSELF

Can be built by anyone, failure impossible. Total cost approximately \$385.00 for all materials. Our large sized blueprints and construction sheets make it a pleasure to build this smartly designed Trailer. Sleeps four—all conveniences beautifully appointed. Factory job would cost over \$1,000—build it yourself and save 75%!

Plans sheet, completely illustrated and detailed for 25c stamps or coin.

The Trailer Plan Shop, 510-919 N. Michigan Ave., Chicago

RADIOS..SAVE UP TO 50%

DEAL DIRECT: Factory Prices. Many models to select from AC-DC, All-wave, Farm, Car and new metal Tube Models. Your name and address on postcard brings you NEW 1936 Bargain Catalog in colors FREE. Get details of 30-DAY TRIAL plan and Agent-User proposition.

Goldentone Radio Co., Dept. 257
8780 Grand River, Detroit, Mich.

RADIO COURSES

RADIO OPERATING: Prepare for Gov't License Exam. • **RADIO SERVICING:** Including Short Wave • **AMATEUR CODE**

• **New Course in ELECTRONICS:**

Day and Evening Classes—Booklet Upon Request

New York YMCA Schools
4 W. 64th Street, New York City

ELECTROCELL

SELF-GENERATING DRY-DISC PHOTO-ELECTRIC ELEMENTS

Ultra Sensitive; Emf. up to 0.8 Volt. 480 Micro-Amp/Lumen. Permanently stable. High Dynamic response. Applicable to frequencies up to 10,000 cycles. Available in a great variety of sizes and shapes. Write for details. Distributor for U.S.A.

DR. F. LOEWENBERG
10 E. 40th St. New York, N. Y.

sample oscillogram of the operation of a half-wave rectifier. There was a failure at the instant of the sharp point in the middle. This set the camera into operation, recording not only the failure itself but also the 2 cycles that preceded and the 2 that followed it.

If, instead of a filament burn-out, a lightning stroke was to be recorded, the oscilloscope might continue on the job for months at a time, visualizing slight flashes of lightning, shooting stars, etc., until a stroke of sufficient magnitude occurred to trig the thyratron tube and thus actuate the camera.

Testing the Uniformity of Metals. Razor blades, even, are now subject to policing by the cathode-ray tube—if the tube indicates "no good," into the refuse pile goes the raw-steel ribbon from which the blade would have been fabricated, as illustrated in Fig. F.

This view shows a cathode-ray oscilloscope connected to the two test coils of an electrical balance. Into the core of the first coil is placed a piece of the regular production steel ribbon, for use as a standard, while through the core of the second coil is drawn the ribbon of similar-temper steel from which (in the factory test illustrated) Gillette razor blades are to be stamped. The slightest deviation in the quality of the steel (excess carbon, bubbles, etc.) will be instantly indicated.

Testing for Tube Noise. Returning now to a test that is of importance to every owner of a radio set, we find that "noise," that most elusive of tube faults, may be made to trace on the tell-tale screen of a cathode-ray oscilloscope, even before the radio tube has left its factory of origin, the abnormalities that otherwise, because of crackles, etc., and even intermittent operation, all due to imperfect welds, loose supports, and so on, would tend to mar the enjoyment of radio programs. The set-up for the above-described tests is shown in Fig. G; when the tube under test is lightly struck with a mallet, the image on the ray-tube screen will show a very irregular waveform if the tube under test is imperfect.

ADDITIONAL APPLICATIONS

The Cathode-Ray Compass. By utilizing a balance circuit and permitting the cathode ray to oscillate regularly between 2 terminals or "buckets," the slightest deflection of this ray from its normal position, as for instance when the entire equipment is aboard ship and the earth's magnetic field links with the field set up by the cathode ray, unbalances the circuit and immediately registers the change.

A Cathode-Ray Ship Locator. By applying substantially the same principle as outlined above, the field set up by even a buoy (perhaps fog-hidden) some distance from the ship on which the cathode-ray equipment is installed, will be instantly indicated.

The Cathode Ray in Geophysical Prospecting. In locating oil domes or rock layer, for instance, the oscillograph is used to record changes in current as microphones pick up sound reflected from rock formations; or, cathode-ray equipment may be used to visualize various current and voltage characteristics as picked up by electrodes spaced on the earth's surface.

The Cathode Ray in Machine Testing. By setting up various mechanical balances of well-known type, so as to produce motion, even though in microscopic degree, minute voltages may be developed, and applied to the cathode-ray tube for visually analyzing variations—in bearings, etc.—too small to be quickly and accurately checked by any other known means.

Cathode-Ray Therapy. The oscilloscope affords a marvelous means of viewing the characteristics of voltages either induced or generated in the heart, muscles, or brain. (The writer predicts that in a relatively short time cathode-ray equipment will be used to steer law enforcement agencies onto the right path in tracking down the truth of statements by suspects and witnesses. The oscillograms of reactions of heart, muscles and brain to certain key questions asked before, and again after, the administration of scopolomine, for instance, when analyzed by experts probably would yield a wealth of useful information. In fact, it is conceivable that some such procedure might, by this time, have eliminated that last bit of doubt that now exists in the minds of many people, concerning the possibility of an accomplice, and the resulting comparative guilt or innocence of Bruno Richard Hauptmann.)

(Continued on page 630)



"Radio will elect the next President"

CARRY ON WITH RAYTHEON!

The Raytheon Line is complete ... 4-Pillar Glass, "G" Type and All-Metal Tubes ... Raytheon's 1936 Sales Campaign will help you sell tubes ... at a PROFIT!

Visit with Raytheon at Booth 15, in the 4th Annual National Convention and Radio Trade Show, Hotel Sherman, Chicago, Ill. March 27, 28 & 29.



TECHNICAL DATA CHART

Raytheon has distributed hundreds of thousands of the previous 8 editions. The NEW NINTH EDITION will be off the press soon! This chart gives all the important characteristics of types formerly listed; includes information on all the new tubes and other valuable reference data — it's NEW! It's UP-TO-DATE! It's FREE!

Headquarters for Tube Information

RAYTHEON PRODUCTION CORP.

30 EAST 42ND STREET NEW YORK, N. Y.
55 CHAPEL STREET NEWTON, MASS.
445 LAKE SHORE DRIVE CHICAGO, ILL.
555 HOWARD STREET SAN FRANCISCO, CAL.
415 PEACHTREE STREET N. E. ATLANTA, GA.

RAYTHEON PRODUCTION CORPORATION
Dept. E-4, 30 East 42nd St., New York, N. Y.

Please send NEW 9th Edition Tube Chart, FREE!

Name PLEASE PRINT

Address

City.....

Cut Prices on Many Popular Radio Books

IMPORTANT—The 17 books listed are ALL different ones from those listed in last month's ad

We herewith present a selected collection of recent important radio books. We have, after an exhaustive study, selected these volumes because they represent the foremost radio books of their kind in print today. There is such a great variety that we are sure it will satisfy any taste as well as any requirement that the student of radio might have.

We publish no catalog and ask you to be kind enough to order direct from this page. Prompt shipments will be made to you direct from the publishers. We merely act as a clearing house for a number of radio publishers and **OUR PRICES ARE AS LOW OR LOWER THAN WILL BE FOUND ANYWHERE.** Remit by money order or certified check. Register all cash.

AUDEL'S RADIOMAN'S GUIDE. by Frank D. Graham. Cloth covers, flexible, size 5x8 1/4", 220 pages, 300 illustrations. **\$.89**

A practical, concise book presenting the theoretical and practical information for the proper operation, maintenance and service as applied to modern radio practice.

EXPERIMENTAL RADIO, by R. B. Ramsey, Prof. of Physics, Indiana University. Cloth covers, size 7 1/2 x 5 1/2", 256 pages, 188 illustrations. Price **\$2.69**

Postpaid **\$2.69**

A marvelous book for the experimenter. Experiments galore in easy comprehensible language.

THE BEGINNER'S STORY OF RADIO, by H. Francis Dashiell. Flexible leatheroid covers. Size 5 1/2 x 8", 96 pages, 63 illustrations. Price prepaid **\$1.75**

This book is written for the advanced radio experimenter who desires an intelligent understanding of what goes on within the radio receiver. The material is easily understood and does not contain complicated technicalities often found in other volumes.

DRAKE'S CYCLOPEDIA OF RADIO AND ELECTRONICS, by H. P. Manly. Cloth covers, size 6x9", 1050 pages, 1080 illustrations. New 1932 Edition. Price **\$4.88**

The largest work of its kind ever put between two covers. New and up-to-date; a standby for every radio man.

FUNDAMENTALS OF RADIO, by R. B. Ramsey, Professor of Physics, Indiana University. Cloth covers, size 9 1/2 x 7", 372 pages, illustrated. Price prepaid **\$3.46**

The backbone of the radio art. This book gives you the foundation on radio from A to Z.

ELECTRICITY AT HIGH PRESSURES AND FREQUENCIES, by Henry L. Transmitt. Paper covers, size 7 1/4 x 5 1/4", 248 pages, 141 illustrations. Price prepaid **\$1.89**

A marvelous book for the student in electricity and radio. General fundamentals lead up to a complete discussion of every type of Tesla and Oudin high-frequency coils, Geissler tubes, etc.; construction details of Tesla coils are given in great profusion. **THE ONLY BOOK OF ITS KIND.**

RADIO CONSTRUCTION AND REPAIRING, by James A. Moyer and John F. Wostrel. Cloth covers, size 8x5", well illustrated, new revised fourth edition, containing 444 pages, still remaining at the same price.... **\$2.50**

A handbook that every radio set tester and general student must have. The diagrams alone are worth the price of the book.

THEORY OF VACUUM TUBE CIRCUITS, by Leo James Peters. Cloth covers, size 6x9", 226 illustrations. 226 pages. Price **\$2.98**

It is one thing to connect green lead No. 1 to pink lead No. 4, but it is another to know why the connections are made. Read this book and learn the design factors in tube circuits.

PRINCIPLES OF RADIO COMMUNICATION, by J. H. Morecraft, Prof. of Electrical Engineering, Columbia University. Cloth covers, size 9 1/2 x 8", 988 pages, profusely illustrated. Price **\$7.35**

THE radio classic, by the dean of radio. Covers entire radio art as does no other book.

THE RADIO MANUAL, by George E. Sterling and Robert S. Kruse, E.E. 2nd enlarged edition. Flexible fabricoid covers. Size 5 1/2 x 8", 805 pages, 318 illustrations. Price **\$5.88**

A complete Radio Course for the operator, the technician, the amateur, the student and experimenter. Everything imaginable in the whole radio art is covered in this great book—the "radio Bible" of the amateur. **DON'T MISS THIS.**

RADIO ENGINEERING HANDBOOK, by Keith Henney. Flexible Leatherette, size 4 1/2 x 7", 584 pages, 482 illustrations. Price **\$4.88**

Each of the 23 sections has been written by a specialist! Includes valuable data on talkies and short waves.

FIRST PRINCIPLES OF TELEVISION, by A. Dinsdale. Cloth covers, size 6x9", 212 pages, 130 illustrations, 38 plates. Price **\$3.46**

A real review of television in design, construction and operation. This amazingly comprehensive book contains many heretofore unpublished facts on this absorbing topic.

HOW TO PASS U. S. GOVERNMENT RADIO LICENSE EXAMINATIONS, by H. L. Duncan and C. E. Drew. Flexible covers, size 9 1/2 x 7", 170 pages, 92 illustrations, appendix. Price **\$1.89**

The most important book on the subject ever published. Gives every conceivable angle which will help you to pass a radio license examination successfully.

RADIO ENGINEERING, by Frederick Emmons Terman. Cloth covers, size 6x9", 700 pages, 425 illustrations. Price **\$4.88**

Not a book for the beginner in radio but a reference volume for the technician who wants modern information on the design and use of band-selectors, automatic volume control, diode detectors, and the thousand-and-one units and circuit arrangements which have been recently developed.

HOW TO ORDER

We cannot ship C.O.D. Our prices are net, as shown. Some of the books sent prepaid (in U. S. only). Those that are not thus listed will be shipped by express collect if sufficient postage is not included by you.

EXPERIMENTAL RADIO ENGINEERING, by John H. Morecroft. Cloth covers, size 6x9", 346 pages, 270 illustrations. Price **\$3.46**

A student's book; devoted to the principles of radio apparatus; intended to accompany a course in electricity. The best of its kind.

RADIO OPERATING QUESTIONS AND ANSWERS, (Revised Fifth Edition), by Nilsen and Hennings. Cloth covers, size 5 1/2 x 8", 390 pages, 96 illustrations. Price **\$2.47**

Contains over 600 questions and answers covering all phases of licensed radio operation. Revised to contain much new material. Nothing better in print.

5 METER RADIOTELEPHONY, by Frank Jones. 52 pages, 89 illus. Per copy, **\$.25** postpaid

Here you learn to construct a variety of 5 meter transceivers and antennas. Written by the designer of the 5 meter equipment for the San Francisco Bay Bridge.

RADIO PUBLICATIONS

99A HUDSON STREET

NEW YORK, N. Y.

THE VERSATILE CATHODE-RAY TUBE

(Continued from page 629)

The additional uses for cathode-ray equipment rapidly are becoming legion, and foresighted individuals interested in "going places" in the fields of electronics will do well to investigate this new field.

Before concluding this article, there is just one more subject the writer wishes to bring to the attention of *Radio-Craft* readers, and that is the lack of agreement between radio men on the terms they use every day.

OSCILLOSCOPE OR OSCILLOGRAPH?

A few readers may have noticed that in this article the writer uniformly (as delineated in the first paragraph of the article, "Fundamental Facts About Cathode-Ray Tubes," in the April, 1935 *Electronics* Number of *Radio-Craft*, page 594) has used the word *oscilloscope* in referring to those instruments which afford only momentary visual images of transient electrical phenomena; and the word *oscillograph* where means (usually, photographic) were provided for securing graphic record of the ray-tube screen image for subsequent reference. This appears to be the usage that is most in accord with the generic meaning of the words (where *scope* means "to see"; and *graph* means "to write"), and avoids the misunderstandings contingent upon more loose use of the terminology.

However, rather than attempt, single-handed, to establish or even confirm precedent in this respect, the writer has solicited comments from those representative organizations in the field which are most closely associated with cathode-ray equipment. A summary of these comments follows:

General Electric Co. Your distinction between "oscilloscope" and "oscillograph" is correct, and justified by the latest edition of Webster's New International Dictionary. The present General Electric practice is to use the word "oscillograph" even when the instrument is used for visual observation only. Our engineers feel that "oscilloscope" is too restrictive, since, with a

proper camera attachment, any such device could be made recording.

Radio Manufacturers Association. The RMA does not have any established definitions for oscilloscope and oscillograph. The Institute of Radio Engineers has handled subjects for technical definitions in the radio field, whereas, the RMA have, with a few minor exceptions, confined themselves to so-called manufacturing standards.

Author's Note: The writer of the preceding paragraph continues—"My own personal view of the difference between the two names is that an oscilloscope is primarily a device for looking at the 'picture,' such as the sine wave, without making a permanent record. On the other hand, I visualize the oscillograph as a device which was used primarily for making permanent records, although it could be used for viewing an image on a screen. I was under the impression that the term 'oscilloscope' was employed primarily to refer to a cathode-ray type of instrument. Of course, with a camera an oscilloscope could readily be considered as changing into an oscillograph."

The Institute of Radio Engineers. The Technical Committee on Electronics which would handle definitions of the terms "oscilloscope" and "oscillograph" have not prepared such definitions and hence there is no final statement which can be made representing the Institute's opinion in the matter.

General Radio Co. While the word oscillograph strictly speaking means an instrument which furnishes a record, the term has been in use for a number of years to describe instruments which are not recording. In our catalogs, we have used the term oscillograph to describe an instrument which you apparently call an oscilloscope, and we shall probably continue to do so.

The only dictionary at hand at the moment is Webster's Collegiate Dictionary, and according to this edition the word oscillograph may be an apparatus for recording or indicating.

It seems that the only criterion which can be applied to a controversy of this sort is that of common usage, and it seems that 99 out of every 100 engineers call a cathode-ray tube an oscillograph. However, on the basis of the

derivation of the words, the contention you make is undoubtedly correct.

Bell Telephone Laboratories. Those of us in these Laboratories who are particularly concerned with publication use the words "oscilloscope" and "oscillograph" as you state you understand them, and what amounts to the same thing, as they are defined in Webster's dictionary. The word "oscillogram" is sometimes used for the resulting picture. There is also a natural tendency to call the instrument which permits recording an "oscillograph" even though at the moment one may be using it to see the waveform rather than to record it.

The Clough-Brenkle Co. Without any regard to the standard "handbook" or Webster's Dictionary, we have, in our literature, made the following differentiation between these words:

(1) Oscilloscope is a device embodying the cathode-ray tube and the attendant power supply.

(2) Oscillograph is the same as the above instrument, but with the addition of a horizontal sweep circuit device, which enables the picturization of voltage rises and falls with respect to time.

We do not confirm the belief that an oscillograph necessarily comprises the element of permanency, but would rather suggest that it means the graphing or the picturization of something with regard to time; whereas the oscilloscope is purely a representation of two potentials with regard to some rule for analytical discussion.

Fig. G. Ray-tube testing for "Noise."



Please Say That You Saw It in RADIO-CRAFT

RCA Manufacturing Co. (This interesting reply is so detailed that we have reserved it to the last, as follows.—Author.)

The original coinage of the words "oscilloscope" and "oscillograph" apparently has but little influence on their present usage. The body of each of the words is derived from the Latin "oscillare," meaning "to swing." The suffixes are both derived from the Greek: scope from "scopos," meaning "watcher"; graph from "graphos," meaning "writer." Webster's New International Dictionary makes the words synonymous. It defines "oscilloscope" as "an instrument for showing visually the changes in a varying current, an oscillograph." The definition of "oscillograph" is, "an instrument for recording or indicating alternating current wave forms or other electrical oscillations."

Funk and Wagnall's Practical Standard Dictionary gives no definition of oscilloscope but defines an oscillograph as "A device for obtaining a visible representation of the oscillations of an alternating current, which are transmitted in the form of reflected light rays to a screen for observation, or to a moving photographic film for purposes of record."

Bedell and Reich named their complete apparatus an "Oscilloscope," giving the literal translation of the word as their justification. However, subsequent manufacturers of similar equipment have called their products oscillographs because of the similarity of the application of these instruments to that of the electromechanical oscillograph. This similarity has also given rise to the popular usage of the word.

Investigation of current literature on the subject shows that instruments giving a permanent record, photographic or otherwise, are referred to as recording oscillographs.

Another recent usage of the word "oscilloscope" has been to refer to a manufactured cathode-ray oscillograph containing only a power supply and not incorporating a sweep circuit into the mechanical design of the apparatus. This is apparently the accepted usage of the term.

Although technical writers have avoided the use of the word "oscilloscope," several other definitions of "oscillograph" and "cathode-ray oscillograph" exist:

(1) "Cathode-Ray Oscillograph—an apparatus for delineating the instantaneous value of the current or voltage in a circuit by the deflection which a magnetic or electric field produces on a fine cathode-ray stream passing through the field."

(2) "An Oscillograph is an instrument for recording photographically the waveform of an electric current or impulse."

(3) "Oscillograph—

A—An instrument for recording rapid variations of an electrical current or pressure, usually consisting of a combination of a suitable form of galvanometer with a photographic recording apparatus.

B—A cathode-ray tube in which the cathode-rays are deflected by the application of a magnetic field."

(4) "An oscillograph is an instrument which gives a graphical record or a visual indication of the manner in which a rapidly-changing current or voltage varies with time."

In a recent article in *Radio Engineering* magazine for June the writer has defined the instrument as follows:

"The cathode-ray oscillograph is a device for accurately observing, measuring, or recording the instantaneous effects of changes in electrical circuit parameters. One or more effects, which may occur in only a few microseconds or after several seconds, as a result of varying such parameters as current, voltage, inductance, capacity, resistance, impedance, etc., is indicated as an image on the screen of a cathode-ray tube."

Since such a variety of definition is encountered in authoritative literature on the design and use of the apparatus, it seems advisable to accept the common usage of the manufacturers and users.

References:

- (1) Webster's New International Dictionary
- (2) Funk and Wagnall's Practical Standard Dictionary
- (3) Electrical Dictionary—Houston
- (4) Dictionary of Applied Physics—Glazebrook
- (5) Journal A.I.E.E. Vol. 46
- (6) Commercial A.C. Measurements—G. W. Stubbings
- (7) Electrical Vibration Instruments—Kennelly

Personally, I consider the oscilloscope a more limited or simplified form of oscillograph and reliable manufacturers are using the term "oscillograph" for a complete instrument but I believe that the term "oscilloscope" will gradually disappear and the term "oscillograph" apply to instruments of either type.

This closes the remarks by RCA's commentator. Expressions from *Radio-Craft* readers concerning this subject will be appreciated, and may tend to reduce the ambiguity that otherwise may be attached to indiscriminate use of cathode-ray equipment nomenclature.

(Credit is here given to *Instruments* magazine for special permission to reproduce the illustration [therein termed a tree of oscillography], prepared by Westinghouse Elec. & Mfg. Co., reproduced here as Fig. A.)

NEW RADIO AND INDUSTRIAL TUBES

(Continued from page 606)

The 307—A High-Power Pentode. Still another new tube is the 307A, which is a pentode designed for mobile radio transmitters. It may be used as a modulator, amplifier or oscillator. The unusual feature of this tube is in the remarkable characteristic which very closely approaches the ideal for this type of tube, and in the fact that the 3 grids are brought out to separate prongs on the tube base.

An outstanding proof that the "last thing" in tube design has not been seen is found in the new "electron image" tubes which Prof. Zworykin has just introduced; the tube shown on the cover of this magazine is one of these remarkable new tubes.

An unusual display of electronic tubes and tube actions was shown recently by the University of Illinois at a science exhibit in St. Louis. As shown in the photo at Fig. D, this display depends primarily upon a "cold-cathode rectifier" capable of handling voltages up to 50,000 V. This tube uses an odd application of a phenomenon known as "Hittorf's principle of limiting the expansion of Crooke's dark space." However, to come back to earth, this display makes use of a cathode-ray oscilloscope to trace the waveform of the current in the rectifier and the combination of fluorescent waveform and the visible discharge in the rectifier tube itself certainly makes an attractive display.

The applications of such a cold-cathode high-voltage tube will be found wherever high potentials are required at direct current (D.C.). The fluorescence and X-ray machines are two very common uses to which it may readily be put.

THE 3-DIMENSION GRAPH

In connection with the heading illustration the following additional data has been supplied by the manufacturer.

The use of older conventional methods of indication of dynamic characteristics on a family of plate characteristics of an amplifier tube is not entirely satisfactory to the circuit engineer in that it is an indirect and tedious method of obtaining the information desired for design purposes. This information covers the operating grid bias voltage and the permissible grid swing associated with different values of coupling resistor. With the usual family of curves the selection of the operating bias and load lines is an uncertain operation unless adequate information and equipment are supplied to show the less apparent limitations, such as grid current region and non-linearity. The type 6F5 tube is used as an example of the general principles involved.

In the use of dynamic characteristics to select the grid bias for a given load resistor, it must be borne in mind that the grid should never swing to a potential less negative than 1 V. This limit should not be exceeded since there is a possibility of grid current in that region due to the effects of initial velocity of emission of electrons from the cathode, contact potential, and other spurious voltages present from the structure of the tube. The straight portion of the curve representing the desired load in the region more negative than the boundary of the grid current region is noted. The center point of this portion of the curve is then selected for the operating bias. In the case of one example this is—1.3 V. for all 3 load resistors. It is obviously far easier to judge the straight operating portion of these curves to obtain minimum distortion than it is with the load lines

THREE

Big Clough-Brengle ANNOUNCEMENTS

1—New Easy Payment Plan

You can now completely equip your laboratory with the latest CLOUGH-BRENGLE Instruments for a small down payment—and pay the balance over six months. The extra income produced by this fine equipment will pay the monthly installments and leave you money ahead.

For instance, you can buy complete Cathode-Ray Equipment, including the MODEL CRA Oscillograph and MODEL OM Frequency Modulated Oscillator, for a down payment of \$49.00 and monthly payments of \$17.15.

Ask your jobber or write for full information.

2—Complete "Service Laboratories" —approved by F.H.A.

CLOUGH-BRENGLE engineers have just completed a new line of "Service Laboratories"—which offer every essential servicing facility in impressive display cabinets. These meet the Federal Housing Administration requirements for their attractive time payment plan. See your jobber or write for new descriptive bulletin.

3—New Spring Catalog

Here is complete information on the most complete and the most popular series of precision radio service instruments ever offered. Cathode-Ray Oscilloscopes, R-F Signal Generators, Set Analyzers, Audio Oscillators, Power Level Indicators—all with the C-B reputation for unequalled performance and value. Get your copy today.

Get the Full Story—TODAY

The CLOUGH-BRENGLE CO.

1130 W. Austin Ave., Chicago, U. S. A.
Cable Address—CEBECO, Chicago

CLIP AND MAIL NOW

Please send at once the following new CLOUGH-BRENGLE Spring announcements:

- New Easy Payment Plan
- F. H. A. Approved "Service Laboratories"
- New Complete CLOUGH-BRENGLE Catalog

Name _____

Address _____

City _____ State _____

My Jobber is _____

AMPERITE HIGH LEVEL VELOCITY MICROPHONE

Operates WITHOUT PRE-AMP HIGH IMPEDANCE—2000 OHMS THIS MICROPHONE IS HIGH ENOUGH IN IMPEDANCE TO OPERATE DIRECTLY INTO GRID . . . BUT NOT HIGH ENOUGH (ONLY 2000 OHMS) TO INTRODUCE SERIOUS LOSSES IN LINE UP TO 200.

Replaces condenser or triode mikes. No changes necessary. Eliminates input transformer and its losses. Eliminates hum, trouble and feedback.

ELIMINATES HUM TROUBLE



MODEL RB-H. for speech and music. LIST \$42.00 with coupling. MODEL RS-H. for speech, but can also be used for music. LIST \$32.00 with coupling. Write for Bulletin H.

New! POSITIVE-AND-SMOOTH-ACTION STANDS

Positive, non-sliding, ball-bearing clutch! Will never wear out, never require adjustment. WILL NOT "CREEP". Tightens with only 1/8 turn of clutch. Mike can be rotated without loosening clutch. SMOOTH, PNEUMATIC-LIKE ACTION up and down. A model for every purpose. WRITE FOR ILLUSTRATED BULLETIN S.

AMPERITE Company 561 BROADWAY NEW YORK

AMPERITE HIGH LEVEL VELOCITY MICROPHONE

CHEKATUBE \$25.63

T. o. b. Factory



Model C111

NEW TESTS ALL METAL AND GLASS

Tubes—no adapters—Get a swell instrument that does more than most \$35 testers. HIGHEST QUALITY—Large meter—Neon short test that shows plate shorts automatically and all other shorts even the metal tube shield. Portable model shown without cover. Ask your jobber for demonstration before buying any other. Or send us his name and receive free literature. Fully guaranteed to satisfy you or money back—See your jobber today.

Established 1922

J-M-P Manufacturing Co., Inc.
3044 N. 34th St. Milwaukee, Wis.

QUALITY recommends

Condensers by SOLAR

WET . . . DRY PAPER MICA . . . THINNER

Please Write for Details

SOLAR MFG. CORP. 599 601 Broadway New York City

AMERICAN MICROPHONE CO., Inc.

CRYSTAL, ELECTROSTATIC, CONDENSER AND CARBON

New catalogue available upon request.

1915 South Western Avenue, Los Angeles, Calif.

RADIO ENGINEERING

RCA Institutes offers an intensive course of high standard embracing all phases of Radio. Practical training with modern equipment at New York and Chicago schools. Also specialized courses and Home Study Courses under "No obligation" plan. Catalog, Dept. RT-38.

RCA INSTITUTES, Inc.

75 Varick St., New York. 1154 Merchandise Mart, Chicago
Recognized Standard in Radio Instruction Since 1909

THE LATEST RADIO EQUIPMENT

(Continued from page 602)

RENEWABLE FUSE (950)

THIS FUSE can be renewed many times, since "blowing" does not render it useless! The fusible element is a slender column of mercury, which boils when the load becomes too high, the boiling opens the circuit and the fuse must be shaken to renew it.

HIGH-FIDELITY-RESPONSE DRY-DISC PE. CELLS (951)

SELF-GENERATING photo-cells of the selenium dry-disc or photovoltaic type are now made which have remarkable characteristics. Reasonable moisture and temperature changes have almost no effect. A special ageing process makes the cells stable over a period of many years. The elements are made in sizes from 3/8-in. dia. (illustrated) to 2 5/8 ins. in dia., and 5/8 x 1 3/8 ins. in rectangular shape. The latter is especially useful for use in constructing batteries. Bakelite cases are made for all types. The electrical output is extremely high. The 1 3/8 in. cell will deliver up to 20 ma. in direct sunlight. Time lag is practically nil; response may be obtained out to 10,000 cycles, it is reported!

FREQUENCY MODULATOR (952)

(Clough-Bregle Co.)

USE of an ordinary oscillator as a frequency-modulated oscillator with an oscilloscope, or as a straight oscillator is possible with this instrument. The fixed-frequency sweep produces a selectivity curve accurately calibrated in frequency. The fixed sweep principle is employed.

TINY "DUAL" ELECTROLYTIC CONDENSER (953)

(Solar Mfg. Co.)

A DUAL unit has been added to the popular line of "Little Giant" (small-space) condensers, shown as item No. 817, Oct., 1935 Radio-Craft. Has removable mounting flanges, and is provided with separate leads so that both sections may be isolated in the circuit. Available in 4-4 and 8-8 mf., and in surge peak ratings of 250 and 525 V.

PORTABLE P.A. SYSTEM (954)

(Lafayette Radio Mfg. Co.)

THE EQUIPMENT pictured has been designed particularly for the use of lecturers and others who need compact, powerful, portable P.A. equipment. The case measures 23x-17 1/2 x 9 ins. and contains a 12-in. photograph turntable with dual-speed motor, either a 12- or 15-W. amplifier, and a mixing panel for control.

TYPEWRITER BARGAIN

FREE HOME TYPING COURSE

10-DAY FREE TRIAL OFFER



ONLY 10¢ A DAY

BRAND NEW MODEL No. 5 REMINGTON PORTABLE

● A brand new Remington for only 10c a day. An easy, practical Home Typing Course FREE. With it anyone quickly becomes expert on this machine . . . the most rugged, dependable portable made. Not used or rebuilt. Standard 4-row keyboard. Standard width carriage. Margin release on keyboard. Back spacer. Automatic ribbon reverse. Every essential feature of big office typewriters. Carrying Case FREE. Try it for 10 days without risking a cent. If you don't agree it is the finest portable at any price, return it at our expense. Don't delay. Without obligation, write now.

Remington Rand, Inc., Dept. 189-4, 205 East 42nd Street, New York, N.Y.

VOLUME CONTROL KITS (955)

A NEW idea for the Service Man and experimenter is the "volume control kit," which incorporates 5 volume controls of most commonly-needed values, 3 snap-on off-on switches, and, free, 5 flexible resistors for average bias-voltage requirements. Wire-wound or carbon controls are optional.

SHOCK-PROOF FUSE TONGS (956)

MADE in 3 sizes, these fuse tongs are very sturdy and compact. They are of hard fibre, riveted together, and may be used for adjusting live switch and cut-out clips, as well as for fuse handling. The unit illustrated is 7 1/2 ins. long, and others are made 12 ins. and 20 ins. long, for higher power work.

GENERATING PLANT (957)

THE GASOLINE-driven power plant shown has a power output of 350 W. at 110 V., so that any type of equipment designed for

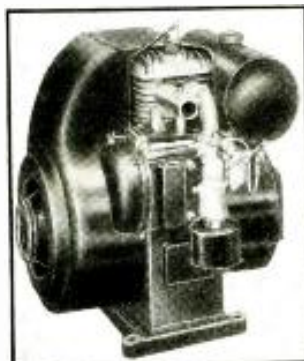

No. 957. A gas generator.

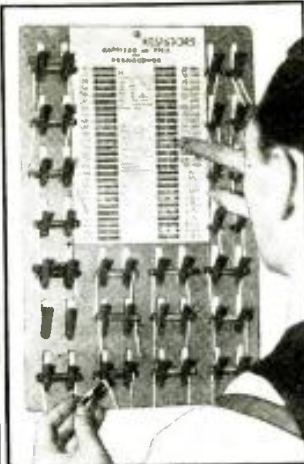

Left, No. 961. A compact condenser.

Above, No. 959. A resistor rack.

Upper right, 958. Velocity mike.

Lower right, 960. Amplifier shield.

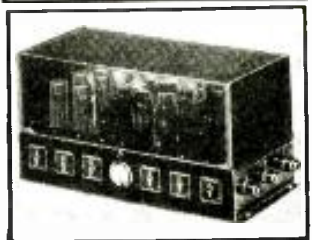
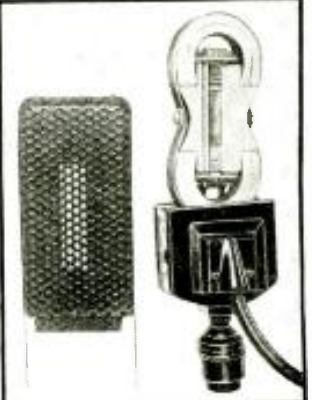

Please Say That You Saw It in RADIO-CRAFT

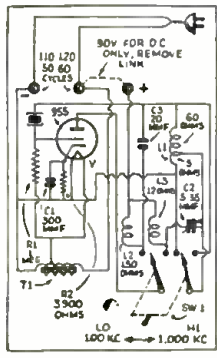

No. 967. Appearance and Circuit of Crystal Calibrator.

use on commercial lines may be operated in isolated locations. The engine is rated at 1 hp. and operates at 1,800 r.p.m. It may be had in self-starting, manual-, or automatic-starting types.

VELOCITY MICROPHONE (958)

A NEW alloy called *Nicalum* is used in the permanent magnets of this microphone, with the result that extremely high sensitivity and small size have been obtained. The built-in transformer is very thoroughly shielded.

RESISTOR RACK (959)

(Central Radio Lab.)

ALL SIZES of resistors are carried by this handy rack, which has printed on it a large, easily-readable chart of the standard R.M.A. color code. The rack is supplied with a resistor kit suitable for most requirements, and may be hung on the wall where it is out of the way but yet very convenient.

AMPLIFIER SHIELD (960)

(Radolek Co.)

PERFECT mechanical protection is afforded by this strong shield. It provides ample ventilation to allow correct operating temperature. The shield is made of heavy steel with a black enamel, baked-on finish. The shield is shown on a 30W. amplifier.

COMPACT CONDENSER (961)

(Aerovox Corp.)

EXTREME compactness and utility are combined in this tiny unit, one of which, a dual 8 mf., is illustrated. Double-section units are made in 250 and 525 V. ratings and combinations of 4-4 to 8-16 mf. Individual leads for both positive and negative are used.

(Continued from page 603)

CRYSTAL-CONTROLLED CALIBRATOR (967)

(RCA Manufacturing Co.)

calibration or checking at innumerable frequencies. The unit is entirely self-contained, and needs only to be plugged into the 110 V., 60 cycle socket. The A.C. modulates the resultant signal, but a D.C. high-voltage supply may be used if unmodulated operation is required. The moulded case is only 5 1/2 x 3 3/4 x 2 1/2 ins. deep. A single, type 955 (triode) "acorn" tube is used in conjunction with a special quartz crystal to assure the high degree of accuracy required in precision work.

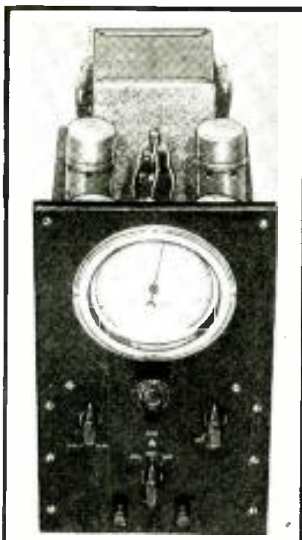
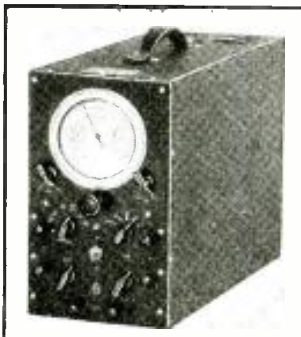

Extreme left, No. 968, Oscilloscope. Below, No. 968, R. F. Oscillator. Right, No. 968, Audio Oscillator.

"LOW IN PRICE . . MIGHTY IN PERFORMANCE"

A NEW



UTC

CK8 METAL TUBE SUPER POWER AMPLIFIER

CK8 transformer kit mounted on chassis with all accessories, except tubes, ready to wire.

35 Watts undistorted output—will handle up to 20 dynamic speakers. 8 tubes used: 3—6C5 triodes, 4—6F6's in Pentode A prime connection, 1—83 rectifier. 95 DB gain. Input of amplifier will match crystal or high impedance ribbon mike outputs. Also adapted for carbon or dynamic mikes through external transformer input.

LIST NET
\$45.00 \$27.00

WRITE to Mr. Barnes for FREE constructional diagrams of this latest CK8 kit

UNITED TRANSFORMER CORP.

76 SPRING STREET NEW YORK, N. Y.
EXPORT DIVISION - 15 LAIGHT STREET, NEW YORK, N. Y.

3-SECTION OSCILLOSCOPE "SYSTEM" (968)

THIS equipment consists of 3 separate and related units, an oscilloscope, an A.F. oscillator and a frequency-modulated R.F. oscillator.

The Oscilloscope. This basic unit is self-contained, being provided with a linear sweep oscillator, a vertical amplifier to increase sensitivity, a horizontal amplifier, a centering adjustment, etc. With amplifier on full, the sensitivity is .75-V. r.m.s. per in. of deflection. All controls are brought to the panel.

The Frequency-Modulated Oscillator. This new companion unit has a hand-calibrated dial reading from 100 kc. to 25 mc. in 6 bands. The frequency modulation is obtained by variation of a rotating condenser which gives a band width of about 20 kc. A large condenser is also mounted with the small one so that the frequency varies over the same range as the main tuning condenser, enabling the oscillator-section of a radio set to be tracked over the entire range without continuously turning the oscillator tuning control at each new frequency setting of the set. An impulse generator is attached to the same shaft to enable synchronization with the oscilloscope.

The A.F. Oscillator. This final unit in the series has a frequency of 400 cycles; the percentage of modulation of the R.F. oscillator may be of any value up to 100 per cent. The beat-frequency oscillator has a directly-calibrated scale reading from 10 cycles to 20,000 cycles. The dial has a total scale length of about 9 ins. A reed is provided for use as a checking point, and when so checked, the dial readings will be correct within 2 per cent. Two output circuits are available, for low and high-impedance use.

The complete "system" utilizes the following tube complement: 1—879, 2—578—906 or 908, 1—80, and 1—885.



25¢

"The Gadget"

Ghirardi and Freed's POCKET TROUBLE-SHOOTER for service men

The handiest gadget ever invented for service men gives 275 specific remedies for all types of symptoms and every possible trouble source. Take it with you on all your calls—as a reminder. It saves hours of wasted time and no end of "headaches."

Send Coupon Today

RADIO & TECHNICAL PUBLISHING CO.
45 Astor Place, N.Y.C., Dept. RC-46

Enclosed find 25¢ for one of Ghirardi & Freed's Pocket Trouble Shooters.

NAME _____
ADDRESS _____
OCCUPATION _____



YOU WANT YOUR OBSOLETE SET ANALYZER OR TUBE CHECKER

Modernized

WRITE FOR OUR PLAN

MENTION MODEL NUMBER OF YOUR OLD INSTRUMENT
MODERNIZATION DIVISION DEPT. "C"

PRECISION

APPARATUS CORPORATION
821 EAST NEW YORK AV., BROOKLYN, N. Y.

A new book to add to your technical library
ABC of AIR CONDITIONING
 by Paul D. Harrigan

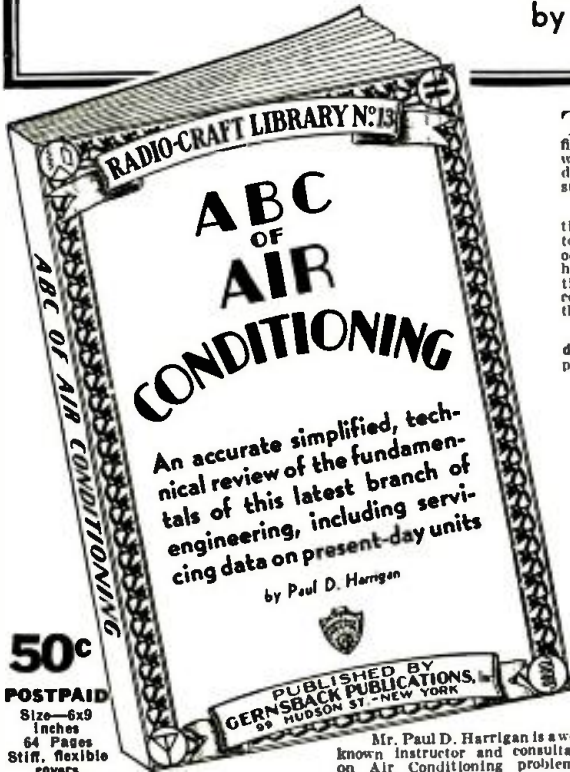

THOSE who are first becoming interested in the fertile field of Air Conditioning will find in this book all the fundamental principles which underlie the practical systems in use today—and written in a way that can be understood by anyone.

The book contains also a step-by-step description of the different types of refrigerating systems, humidifying and de-humidifying methods, air filtering units and heating plants which have been used in Air Conditioning installations, beginning with the invention of artificial cooling and refrigeration and continuing up to the latest types in use today.

The man who wishes to learn about Air Conditioning will do well to start with this comprehensive book.

Brief outline of contents:

- The Future of Air Conditioning
- Uses and Benefits of Air Conditioning
- Elementary Refrigerating Systems
- Types of Winter and Summer Air Conditioning Installations and their Operation
- Service and Control Applied to Air Conditioning Systems
- Ventilation Data for Air Conditioning
- Definitions Used in Air Conditioning
- Air Conditioning Books

Send fifty cents in stamps, money order or coin for your copy of the ABC of Air Conditioning—it is sent postpaid upon receipt of your remittance.

GERNSBACK PUBLICATIONS, Inc.
 99 Hudson Street New York, N. Y.

Mr. Paul D. Harrigan is a well known instructor and consultant on Air Conditioning problems.

CORNERSTONES OF RADIO
—THE BRIDGE

(Continued from page 604)

to adjust, or better, we have to redesign the balance to be used for our experiment, so as to adapt it to our "electrical objects." What we need is a device which permits us "to place" electricity upon the plates of a balance.

After we have found the "main difference" between electricity and "ordinary objects" it is easy to design a balance exactly fitting our experimental needs. We need utilize but a few wires, and send through one side of our imaginary electrical balance the same amount of electricity which goes through the other side. We then apply, in addition, an "electrical zero indicator" (for example a sensitive galvanometer).

That sounds like a fairy tale but as Fig. 4B indicates it is actually possible to design and construct for electrical use such a device as described by mechanical analogy in the previous chapter. In the center of this electrical balance we see a battery. The current provided by this battery is sent by means of 2 wires to the left and right side of the balance. At the right side we see a calibrated resistor, R4 of 10 ohms value cut into the wires, and in addition to this a resistor which is marked Rx (which let us suppose is of unknown value, despite the fact that we know its actual value is 10 ohms). At the left side we find a calibrated resistor, R2, of 10 ohms resistance; and connected to R2 is yet a third resistor, Rv, equipped with a sliding contact that permits the amount of resistance in use to be varied within the range of 0 to 20 ohms. If we want to obtain a zero indication by the instrument (the zero-indicating galvanometer previously mentioned) on the top of this electrical balance, to show us when balance is obtained, we have to vary the slider setting on resistor Rv until the slider rests in front of the "10 ohms" mark, and the trick is completed.

How this was accomplished is very easy to understand if we keep in mind that in varying the position of the slider and hence the amount of resistor Rv in the circuit, we also changed the value or amount of the current flowing in the left side of the balance.

FINDING THE EXACT VALUE OF Rx

However, "balance" is not the main point we have been driving for; instead, we started our experiment with a view to determining the value in ohms of resistor "Rx."

If we look over the resistor values at both sides of our measuring device we shall find that resistor R2 (called the basic resistor because of its resemblance to the plates of the commercial balance) has a value of 10 ohms, and it will be recalled that we added to this resistor (through variation of Rv) a resistance value of 10 ohms. This makes the entire resistance value, cut into the left side of our balance, 20 ohms.

We know further that resistor R4 has a value of 10 ohms, and since we know that we can obtain balance only when the resistance at both sides of the balance is equal, we can easily conclude that the value of Rx, too, must be 10 ohms; since 20-10=10 ohms—or, figured in another way, 10+10=20 ohms.

The example presented above has demonstrated to us the possibility of determining the value of a resistor by means of a bridge, but we do not know how this effect was actually obtained.

Fig. 7. A bridge-type V.T. voltmeter.

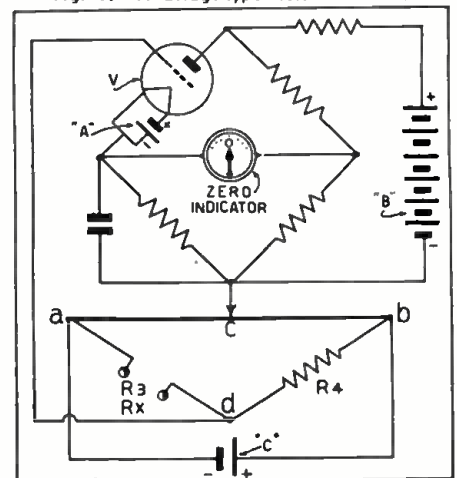

Westinghouse Power Generator

Manufactured for U. S. Signal Corps
 200 Watt. 110. V. AC

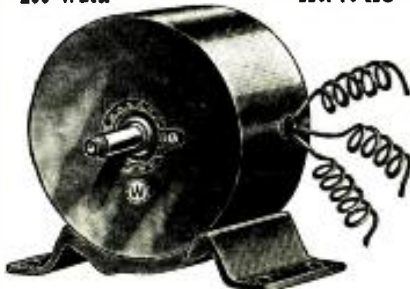

A. C. ELECTRICAL POWER

from a Windmill, from available Waterpower, from your Automobile, from your Motorcycle, from your Bicycle, Foot-pedals or Handcrank (for transportable Radio Transmitters, Strong Floodlights, Advertising Signs); do you want to operate AC Radio sets from 32 V. DC farm light systems; operate two generators in series to get 200 V. AC; obtain two phase and three phase AC, etc., etc.

There Are Over 25 Applications
 Some of which are:

A.C. Dynamo lighting from eight to ten 20 Watt 110 Volt lamps. Short Wave Transmitter supplying 110 Volts AC for operating "Ham" transmitter. Operating 110 V. AC 60 Cycle Radio Receiver in DC districts. Motor Generator. Public Address Systems. Electric Sirens on motor boats, yachts, etc. Camp Lighting. Short Wave artificial "fever" apparatus. Television. Pelton Waterwheel for lighting or other purposes. Airplane: for lighting strong search lights or electric signs. Laboratory work, etc. etc. ¼ to ½ H.P. needed to run generator.

BLUE-PRINT 22x28 in. and Four-Page 8½ x 12 in. INSTRUCTION SHEETS FREE WITH GENERATOR.

Generator, as described, including four replacement carbon brushes. Blue-print and instructions **\$7.90**

Send \$2.00 deposit balance C.O.D. Shipping weight 18 lbs.

(Replacement carbon brushes bought separate \$1.50 per set of four. Set of instructions bought separate \$1.00.)

MONEY-BACK GUARANTEE

WELLWORTH TRADING COMPANY
 560 West Washington Blvd., Dept RC436, Chicago, Illinois

Something NEW!

WEATHER FORECASTER AND HUMIDITY TESTER

"HYGROSCOPE"

The Ace of Weather Forecasters



When placed in a well-ventilated room or in the fresh air, the HYGROSCOPE foretells coming weather conditions from eight to twenty-four hours in advance. It also accurately records outdoor humidity, and when placed inside it gives the humidity within the house or room.

The HYGROSCOPE is automatic self-adjustable, simple American-precision made. It cannot get out of order at any time. The dial measures 2¾". is enclosed in a 6" round hardwood case, with either walnut or mahogany finish. It is attractive for desk or living room.

OUTSIDE DIAL FORECASTS WEATHER

Fair—rain—or changeable is indicated on the outer dial when the HYGROSCOPE is placed in a well-ventilated room or out-of-doors. If indoors, place the instrument near an open window.

INNER DIAL SHOWS THE HUMIDITY CONTENT

The HYGROSCOPE also acts as a hygrometer. Numbers on the inner dial indicate the degree of humidity present in the air and in artificially heated rooms.

SEND YOUR ORDER NOW! Get your HYGROSCOPE today. Your remittance in form of check or money order accepted. If you send cash or unused U. S. Postage Stamps, be sure to register your letter. Also specify if you prefer the HYGRO-SCOPE in Walnut or Mahogany. **\$2.00**

Postpaid

GRENPARK COMPANY

Dept. RC-436
 99 Hudson St. - New York, N. Y.

Please Say That You Saw It in RADIO-CRAFT

12 BOOKS TO HELP YOU LEARN MORE ABOUT RADIO

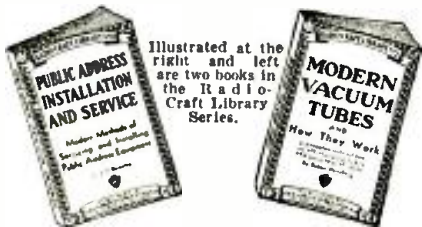

THE RADIO-CRAFT LIBRARY SERIES—a most complete and authentic set of volumes—treats individually, important divisions of radio. Each book has been designed to give you the opportunity to learn one or more branches of radio. The authors of the books are well-known to everyone. Each is an expert radio man; an authority on the subject—each is thoroughly familiar with the field which he represents.

All Books Uniform

The volumes in the RADIO-CRAFT LIBRARY SERIES are all uniform, 6 x 9 inches. Each book contains an average of 50 to 120 illustrations. The books are printed on an excellent grade of paper which makes the type easy reading.

Here Are the Series:

- Book No. 1
RADIO SET ANALYZERS
And How to Use Them By L. VAN DER MEL
- Book No. 2
MODERN VACUUM TUBES
And How They Work By ROBERT HERTZBERG
- Book No. 4
MODERN RADIO HOOK-UPS
The Best Radio Circuits By R. D. WASHBURNE
- Book No. 5
HOW TO BECOME A RADIO SERVICE MAN
By LOUIS MARTIN
- Book No. 6
BRINGING ELECTRIC SETS UP TO DATE
By CLIFFORD E. DENTON
- Book No. 7
RADIO KINKS AND WRINKLES
For Service Men and Experimenters
By C. W. PALMER
- Book No. 8
RADIO QUESTIONS AND ANSWERS
By R. D. WASHBURNE
- Book No. 9
AUTOMOBILE RADIO AND SERVICING
By LOUIS MARTIN
- Book No. 10
HOME RECORDING AND ALL ABOUT IT
By GEORGE J. SALIBA
- Book No. 11
POINT-TO-POINT RESISTANCE MEASUREMENTS
By CLIFFORD E. DENTON
- Book No. 12
PUBLIC ADDRESS INSTALLATION AND SERVICE
By J. T. BERNSELY

BIG DISCOUNT OFFERED

When Five (5) Books or More Are Ordered, Deduct 20% from Your Remittance

GERNSBACK PUBLICATIONS, INC.
99 Hudson Street, New York, N. Y.

MAIL THIS COUPON TODAY!

GERNSBACK PUBLICATIONS, INC.
99 Hudson Street, New York, N. Y.

I have circled below the numbers of books in the RADIO-CRAFT LIBRARY SERIES which you are to send me, and have deducted 20% for ordering five (5) books or more. I have included my remittance in full, at the price of 50c each, when less than five books are ordered.

The amount of my remittance is.....
(stamps, checks or money orders accepted). Circle numbers wanted:

1 2 3 4 5 6 7 8 9 10 11 12

Name

Address

City State

All books are sent postage prepaid

RC-436

The first step in discovering the secret of the balance function is to redraw the balance circuit as shown in Fig. 4B in such a manner as to obtain more simplicity.

How the simplified balance circuit therefore looks is shown by Fig. 4C. If we compare connection for connection, we will find that the balance circuit shown in Fig. 4C is absolutely identical with the one presented in Fig. 4B.

In order to learn how such a balance actually operates we shall construct still another balance—but, this time, one made of glass-tubes and small pieces of rubber-hose as shown in Fig. 4D.

As the arrows indicate a water stream flows from the tank to the "T"-shaped glass tubing indicated as "a." At this point the water stream will be divided into 2 branch streams. One of these smaller water streams will flow through the lower branch, "a to d and d to b"; while the second one flows through the upper branch, "a to c and c to b," and then is again collected by the second glass "T" marked "b," and so back into the tank.

It is easy to believe that water also will flow from the third glass "T" marked "d" and from the fourth glass "T" marked "c" into the middle tube here shown furnished with a water wheel as the zero indicator. If we regulate valves V3 and V4 so that more water flows through branch a-d-b than flows through branch a-c-b the small water wheel will rotate in the same direction as do our clocks and watches—that is, "clockwise."

If we decrease the amount of opening of valves V3 and V4 but increase the amount for valves "V1" and "V2", the zero-indicator wheel will rotate in the opposite direction. In case both sets of valves are adjusted to let through an absolutely equal amount of water, no water will flow through the center tube.

THE ELECTRICAL BALANCE IS A BRIDGE

About the same situation occurs in the electrical system as shown in Fig. 4E (see also Fig. 4C). That is, as long as the resistance of branch R1—R2 is equal to the resistance of branch R3—R4 no current will flow over the wire c-d that bridges both branches—and the galvanometer (cut into the bridge wire) therefore will indicate zero. The experience presented by the last sentence has been condensed into the following formula, which is of great importance for experimenters who desire to build such a bridge: The indicator shows zero when

$$\frac{\text{resistance of a-c}}{\text{resistance of c-b}} = \frac{\text{resistance of a-d}}{\text{resistance of d-b}}$$

or if the same formula is written in a more simplified manner, the galvanometer will indicate zero, when:

$$\frac{R1}{R2} = \frac{R3}{R4}$$

Since mathematics is a subject that generally is not well liked, modern electrical bridges are furnished with the long, stretched wire shown in Fig. 5 as "a to b", in place of the separate resistors, "R1 and R2" shown in Fig. 4. Along this single heavy wire, a-b, there is fixed a calibrated scale, and over wire a-b is arranged a slider contact which may be slid to any intermediate point between terminals a-b. The slider not only makes contact with the wire a-b but also carries an indicator or pointer which moves over the calibrated scale.

ACCURACY OF THE BRIDGE

Despite the fact that there are many other means provided to measure a resistance, with (Continues on page 637)

Fig. 8. A capacity-measuring bridge.

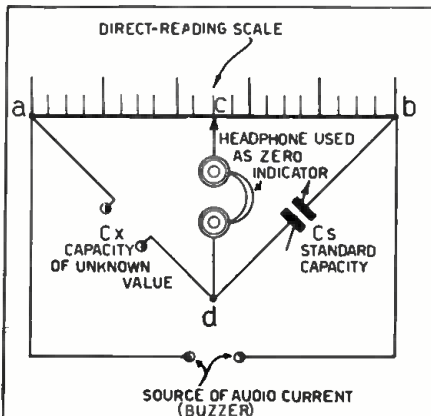

CALLING all Servicemen!

When "Squad-car" Centralab is at the wheel things happen. He stands for no foolin'. Out goes that noisy control on its ear... and a smooth, efficient CENTRALAB RADIOHM preserves the peace.

The best pacifier for noisy receivers, servicemen agree, is a Centralab Radiuhm... and... a mere handful will service practically any set ever made... and make it work "better than ever before."



Every Radio Service Man should be a member of the Institute of Radio Service Men

Centralab

MILWAUKEE WIS.
RADIOHMS SUPPRESSORS
FIXED RESISTORS
WAVE CHANGE SWITCHES

The Streamline AUTO ANTENNA

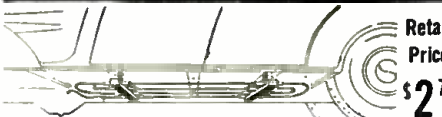

Retail Price \$2.75

NOW EVEN GREATER DISTANCE CLEARER RECEPTION

RUBBER INSULATED

SIMPLE NEAT INSTALLATION
ADJUSTABLE BRACKETS

If Your Dealer Cannot Supply Send Money Order for \$1.75 Sample Prepaid

SEND NAME OF YOUR JOBBER

VICTORY MFG. & DISTRIBUTING CO.
Dept. 2 2021 Michigan Ave. Chicago

NEON

Fascinating home-study course prepares you quickly for today's biggest opportunity—NEON—"gaseous tube" lighting—most widely used medium of lighted displays, the future's greatest source of illumination. Trained men needed in every locality! Start now while the industry is still new!

FREE Booklet describes NEON'S opportunities complete data on C. L. home-study course. Enrollment fee amazingly low. Write for FREE BOOK!

Commercialite Laboratories, Box 47-R, Omaha, Nebr.

Be Prepared to Meet All Radio Servicing Emergencies

WITH GERNSBACK OFFICIAL RADIO SERVICE MANUALS



Just as we say—"Be prepared to meet all radio servicing emergencies with the Gernsback Official Radio Service Manuals." You never know when a service job requires that "extra" special attention. It might mean the difference between doing the job or losing it. You're safe if you have on hand the GERNSBACK MANUALS—either for regular service work or for servicing auto-radios. **Get your copy today!**

No other radio book is comparable to the new 1935 OFFICIAL RADIO SERVICE MANUAL. In contents, in style of printing, in grade of paper, in illustrations, there has never been published such a comprehensive volume.

This Manual contains over a thousand pages—yet it is only 1 1/4 inches thick because it is printed on a special Bible stock which is an exceptionally good stock, yet one of the thinnest and most durable papers. This 1935 Manual is the most authentic and elaborate service guide ever used in the radio industry.

Contents of the 1935 Manual

Over 1,000 pages full of diagrams and essential information of manufactured receivers—only data of real use in servicing is included. This new Manual is really portable since it is extremely thin and light as well. • Volume V continues where the preceding manual left off. • Many circuits of old sets are included. • Service Men know every set has certain weak points which are really the cause of trouble. Wherever the information could be obtained, these weaknesses with their cures are printed right with the circuits. This is an entirely new and valuable addition to the Manual. • All the latest receivers are included—all-wave sets, short-wave sets, auto-radio sets, midget and cigar-box sets, etc., as well as P.A. Amplifiers and equipment,

and commercial servicing instruments. • The cumulative index is even more complete than before; including cross-references to sets sold under different names and type numbers. • Volume V includes resistance data; socket layouts; I.F. data; and voltage data. • Tube data on latest tubes. • Free question and answer service—as included in our last three manuals.

OVER 1000 PAGES

Over 3,000 Illustrations
Size 9" x 12"—only 1 1/4" thick
Flexible, looseleaf leatherette cover

\$7.00
 List

Which of These

GERNSBACK RADIO SERVICE MANUALS

Do You Need to Complete Your Files?

- 1934 Official Radio Service Manual
 Over 400 Pages. 9x12 Inches.
 Over 2,000 Illustrations
 Flexible, Looseleaf. Leatherette Cover
 List Price **\$3.50**
- 1933 Official Radio Service Manual
 Over 700 Pages. 9x12 Inches.
 Over 2,000 Illustrations.
 Flexible, Looseleaf. Leatherette Cover
 List Price **\$5.00**
- 1932 Official Radio Service Manual
 Over 1,000 Pages. 9x12 Inches.
 Over 2,000 Illustrations
 Flexible, Looseleaf. Leatherette Cover
 List Price **\$5.00**
- 1931 Official Radio Service Manual
 650 Pages (Including Supplements)
 9x12 Inches
 Over 1,500 Illustrations
 Flexible, Looseleaf. Leatherette Cover
 List Price **\$4.50**
 (Including Supplements)
- 1933 Official Auto-Radio Service Manual
 (Volume I)
 Over 200 Pages. 9x12 Inches.
 Over 500 Illustrations.
 Flexible, Looseleaf. Leatherette Cover
 List Price **\$2.50**

SET SERVICING
 Service information found in the Manuals covers all types of radio receivers. The material is extremely valuable to Dealers and Service Men. On many diagrams appear voltage readings of tubes, socket connections, transformer data, alignment details, and other service notes.

PUBLIC ADDRESS
 The pages on P.A. Installation will be helpful to Service Men and P.A. specialists. Such prominent features as class A and B amplifiers—single and dual channel systems—attenuators, and mixers—superpower stages—preamplifiers and other commercial devices for P.A. work are included.

ALL WAVE RECEIVERS
 Information relative to short-wave receivers have found their way into the Manuals. For these standard manufactured sets, wherever possible, complete aligning details for all wave bands are included in addition to the service material listed for other sets.

AUTO-RADIO RECEIVERS
 All available service information on new auto-radio sets has been included. From this data alone Service Men could derive sufficient knowledge to venture in a specialty field—that of servicing only auto-radios.

—for the real auto-radio servicing "dope," you can't find a better book!

The 1935 Official Auto-Radio Service Manual

Every radio man connected in any way with the booming auto-radio business needs a copy of the new OFFICIAL AUTO-RADIO SERVICE MANUAL. It contains only auto-radio service "dope."



HERE ARE HIGHLIGHTS OF THE 1935 AUTO-RADIO SERVICE MANUAL

240 pages crowded with diagrams, service material and other essential data required for proper servicing of new auto-radio receivers. Included are diagrams of sets which appeared during 1934, and which were not included in the supplements to the first edition. Cumulative resistance diagrams, chassis layouts, voltage tolerations and servicing instructions are included for practically all sets. "Under-ship" tube symbols are also included to facilitate the job of servicing the sets. Instructions are included with many sets telling how to suppress stubborn cases of ignition interference. This includes the newest "suppressionless" sets and what to do when interference is encountered with this type of set. Details on how to make installations in "turret-top" cars are included. The different methods used by car makers and set manufacturers are listed with the individual circuits and service information. The index contains the listing of sets which were published in the first edition, as well as the sets which appear in the new volume. This information helps the Service Man to locate the circuit and also sets for any receiver that has been made. The book is bound in a handy, flexible leatherette cover. To be sure the book is sturdy, to withstand constant use, the book is printed on a special "bible" stock. This is a very durable, but thin paper. The book printed on this paper can be easily rolled to fit into your pocket or slipped in the service kit.

240 Pages
 Over 500 Illustrations
 Size 9" x 12"

Flexible, Looseleaf Leatherette Cover

\$2.50
 LIST

MAIL COUPON TODAY FOR ANY MANUAL!

GERNSBACK PUBLICATIONS, Inc. RC-436
 99 Hudson Street, New York, N. Y.

Enclosed you will find my remittance of \$ _____ for which please send me promptly, POSTPAID, the OFFICIAL RADIO SERVICE MANUAL indicated.

- | | |
|--|--|
| <input type="checkbox"/> 1935 Edition @ \$7.00 | AUTO-RADIO MANUALS |
| <input type="checkbox"/> 1934 Edition @ \$3.50 | <input type="checkbox"/> 1935 Edition @ \$2.50 |
| <input type="checkbox"/> 1933 Edition @ \$5.00 | <input type="checkbox"/> 1933 Edition @ \$2.50 |
| <input type="checkbox"/> 1932 Edition @ \$5.00 | |
| <input type="checkbox"/> 1931 Edition @ \$4.50 (Including Supplements) | |

Name _____
 Address _____
 City _____ State _____

(Send remittance by check, money order, or register letter if it contains cash. currency or unused U. S. Postage Stamps.)

GERNSBACK PUBLICATIONS, Inc.

99 Hudson Street

New York, N. Y.

OVERSEAS READERS!

These books can be obtained from the following houses:

GREAT BRITAIN
 Gorrings, 9a, Green Street, Leicester Square, London, England

FRANCE
 Editions Radio, 42 Rue Jacob, Paris

AUSTRALIA
 McGill's 183-195 218 Elizabeth St., Melbourne, C. I

CORNERSTONES OF RADIO —THE BRIDGE

(Continued from page 635)

respect to accuracy no other device surpasses the bridge circuit. The more exact is the calibrated resistor R4, and the finer is the point of contact of the slider c, the greater will be the accuracy of the measurements made (provided that one and the same galvanometer is used as the zero-indicator.)

Since very sensitive galvanometers are quite expensive and not very sturdy, they are often replaced by less sensitive ones, used in connection with *vacuum-tube voltmeters*. (See Fig. 6). To obtain stable operation of such vacuum-tube voltmeters, they are, themselves sometimes designed as bridge circuits as shown by Fig. 7.

ALTERNATING-CURRENT BRIDGES

While the bridges described may be used only for *direct-current* (or "D.C.") measurements there are in addition a great many *alternating-current* (or "A.C.") bridges in use; mostly, to determine the value of a condenser, inductance, frequency, etc. Note that the *principle* of alternating-current bridges is identical to that for direct-current bridges.

Measuring Capacity. For example, let us set up the circuit shown in Fig. 8, in which a calibrated condenser, Cs, used as a "standard," is cut into the bridge between points d and b; and condenser Cx (of unknown value) is to be connected to terminals a-b.

Since alternating-current devices are to be measured, a direct-current source (for example a battery) is, of course, not suitable; instead, a *tube oscillator*, or, usually, a high-grade *buzzer*, which generates a "clean" (single) audio-frequency (or "A.F.") tone may be used. Since there is no direct current applied, instead of a galvanometer another zero indicator which is sensitive to alternating current. (ordinarily, a highly-sensitive headphone) is utilized for this service.

Measuring Inductance. A bridge for measurement of *inductance* is shown in Fig. 9. The make-up is about the same as used for the capacity bridge (Fig. 8), except that a calibrated inductance standard Ls is cut in between points b and d, while the inductance Lx, of unknown value, must be connected to the terminals connected to points a and d.

In both bridges, slider c is moved along the slide-wire, a-b, until *no tone* is heard in the headphones.

ADDITIONAL USES OF THE BRIDGE

The bridge circuit is for example an excellent agency for neutralization of two adjacent radio circuits. The bridge principle also is often used for securing various compensating effects in circuits. It is frequently employed as the main factor in "trick," or reflex circuits, and in certain superheterodyne connections.

This last example is an excellent illustration of the involved and important nature of the balance principle. If the grocery man does not keep his balance in order, we do not get the correct amount of grapes; or, again, if someone is mentally "out of balance," people call him crazy. The balance principle therefore is of vast importance. It governs the most simple devices but, strange as it may seem, the *simpler the device, the more difficult it is to recognize the presence of the balance principle.*

Fig. 9. An inductance-measuring bridge.

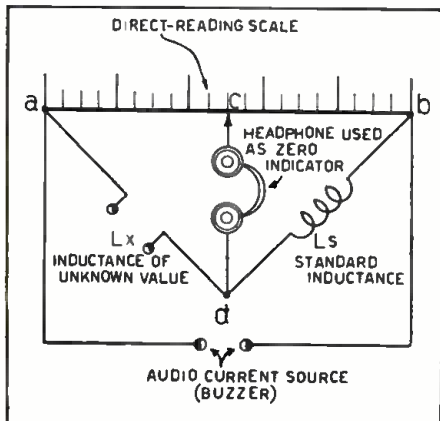

NEW!!! POWERFUL A. C. 3-TUBE TRANSCEIVER



Here is a 5 and 10 meter transceiver that is in a class by itself! With its husky output and good modulation it makes an ideal "second" set for local work. Take it with you this Summer and plug it in anywhere that 110 v. A.C. is available. The way it punches through the Q.R.M. will surprise you. Can be used as a fixed transmitter with separate receiver, allowing maximum output adjustment.

- Use 2 42's and an 80
- 3 Watt carrier on 5 meters.
- Operates direct from 110 volt A.C. power line
- Separate regeneration and volume controls on reception;
- Give maximum sensitivity and minimizes receiver radiation
- Smooth, stable super-regenerative reception operates either speaker or earphones
- Self contained power supply using large 30 H smoothing choke and two 8 mf. filter condensers.
- Works on both 5 and 10 meters with interchangeable plug-in coils.

Complete kit, less tubes and Cabinet

\$11.50

Wired and tested \$3.50 extra. Cabinet \$1.50. Kit of 3 tubes \$1.60

RADIO CONSTRUCTORS LABORATORIES

136 LIBERTY ST. DEPT. H, NEW YORK, N. Y. EXPORT DEPT. 105 HUDSON ST., N.Y.C.

USES OF LOW-VOLTAGE THERMIONIC RECTIFIERS

(Continued from page 607)

these tubes in electronic work, in radio and A.F. amplifiers, to run reproducers (fields), telephone apparatus such as dial selector switches and relays, solenoids and even to run D.C. motors. The most important and frequent use however has been as filament supplies for large A.F. amplifiers in fine residences where any hum at all was objectionable. (See "A \$30,000 Radio Installation," in February, 1936, *Radio-Craft*.)

The writer will be glad to give further data on request. Kindly enclose a stamped and self-addressed envelope.

AN EASILY-MADE STROBOSCOPE FREQUENCY METER

(Continued from page 607)

tions per minute, which corresponds to 630

$\frac{630}{60} = 10.5$ r.p.s. (revolutions per second). There-

fore, as the glow bulb lights up 4 times per revolution of the disc it is evident that the frequency is

$\frac{630}{60} \times 4 = 42$ cycles per second.

Applying to the glow tube the same frequency we may have it light up only in 2 positions when the number of revolutions is increased

$\frac{1,260}{60} \times 2 = 42$ cycles.

Suppose now the tube glows in 8 positions and the disc seems at stand-still when the motor makes 2,802 revolutions per minute. The meas-

ured frequency is $\frac{2,802}{60} \times 8 = 372$ cycles per

second. This method can also be used to synchronize a television scanning disc without recurring to the use of a synchronous motor.

In the circuit of this device, Fig. 1, F1 and F2 are the field coils of the motor; and B1 and B2, the carbon brushes. The resistance of resistor R is about 300 ohms. The motor if of "universal" type can be operated either on A.C. or D.C.

This simple unit was described in a recent issue of *Radio-Well* magazine.

MEMBERS' FORUM

(Continued from page 612)

line filter and creates a great disturbance in my receiver and many others in the neighborhood.

As a radio Service Man, I knew what would cure the trouble. I complained to the manager, and having a suitable filter on hand I persuaded him to plug it in and noted that the interference had practically disappeared from my set. I went back several days later, expecting that I would have a nice sale, but instead the filter was handed back to me and the manager said he was afraid the company would object to the attachment and several other excuses.

Now I don't care where they buy their filter, but I do want that noise stopped. Is there any way to force them to correct the condition? In case the company refuses to take any action, is there anything I can do to improve the condition?

H. C. SLAYTON,
Mokenca, Ill.

Please Say That You Saw It in RADIO-CRAFT

COMPARE THE VALUE!

Ready to Use
\$21.95

KIT
\$17.85

FOR THIS DOUBLE-DUTY



Model 305

"DEPENDABLE" TUBE & SET TESTER

This is the most practical and efficient piece of testing equipment you could want. Takes all glass and metal tubes and roaming filaments. Has 5" fan-type, full-view "Good-Bad" meter. Simple to operate, needs no adapter.

EFFICIENT—CONVENIENT—LOW PRICED

In addition to testing all tubes, this double duty instrument also tests shorts and leakages with neon indicating lamp. Makes capacity and ohmmeter tests, also tests all types of condensers. Has separate line voltage meter. This instrument is really a remarkable value at the price—a piece of equipment every up-to-date service man needs. Also available in portable-combination and de luxe models.

Write Dept. RC-4 for Bulletins.

RADIO CITY PRODUCTS CO.
88 Park Place, New York City

CONDENSERS
ELECTROLYTIC
CONDENSERS

C D

1910-1936

Catalog and Descriptive material upon request.

CORNELL-DUBILIER CORPORATION

4347 BRONX BOULEVARD
NEW YORK

ELECTRICAL BOOKS

shipped
FREE

**10
BIG BOOKS**

**A-C-RADIO
TELEVISION**
EVERY ELECTRICAL
SUBJECT COVERED

Here's great news for anybody interested in Electricity. BRAND NEW edition of Applied Electricity brought right down to date with every NEW Electrical subject fully covered. 10 big Volumes and all shipped FREE for examination. See special offer below.

For Beginners and Experts

Over 3000 pages—hundreds of illustrations—the most complete work of its kind ever published. Diagrams, notes, power stations, radio, television, everything electrical explained clearly so anyone can understand them.

FREE

S. Gerstner's famous Radio Encyclopedia (latest edition) given free with these electrical books if you send NOW. Invaluable in any Radio work. Covers whole Radio field.

American Technical Society, Drexel at 58th St., Dept. E-126, Chicago

Sent for 10 days free use. BRAND NEW 10 volume set of Electrical Engineering. Includes free membership in the American Technical Society and S. Gerstner's Encyclopedia. I will pay the few cents delivery charges on the books. If I wish I may return them in 10 days and owe you nothing, but if I keep them I will send \$2.00 after 10 days, then \$3.00 a month until the special price of only \$29.50 is paid.

Name.....

Address.....

City..... State.....

Attach letter stating age, occupation and name and address of employer and at least one business man as reference.

Short-Checker Kit \$1.00

Radolek offers you the Special Continental Short Checker Kit described in this Publication for only \$1.00 postpaid. Clip the Radolek coupon below and attach to your order.

New! PROFIT GUIDE



Just Off The Press!

- 164 Pages
- New Items
- New Prices

The Radolek New 1936 Profit Guide is the most complete Radio Parts Catalog ever published. Completely revised—right up to the minute, bringing you everything in Radio—at the right prices. Every page brings you extra profits! Contains over 10,000 Individual Radio Repair Parts—hundreds of new items—a complete new selection of Receivers, Amplifiers, Tools, Tubes, Books and Instruments. Everything you need—always in stock... ready for prompt shipment to you. You need this Big Radio Parts Catalog—it's FREE. Send for it!

RADOLEK

MAIL THIS COUPON!

RADOLEK—582 W. Randolph—Chicago
Send The Radolek Profit Guide Free

Name.....

Address.....

Service man? Dealer? Experimenter?

DIRECT-IMPEDANCE AMPLIFICATION

(Continued from page 609)

low-frequency gain of the amplifier, it might seem that the elimination of hum would be a serious and difficult obstacle, but such is not the case.

It is unnecessary to purchase heavily-shielded A.F. chokes to arrive at completely hum-free performance. The fact that considerable current is flowing through the windings limits the inductive pick-up.

The uninitiated constructor would very likely connect units 1 and 2 with a 4-wire cable. Nothing could be more disastrous to humless performance. It is always essential that the plate-to-grid lead be separate from the rest of the cable, but may be wired to the same plug and allowed to hang loosely from the cable.

THE LOW-FREQUENCY UNIT

The low-pass filter which precedes the final 2A5 is so adjusted as to pass only notes below 70 cycles, to any extent. As shown in the diagram, it is composed (a) a small A.F. transformer with the primary shunted and (b) a bypass condenser of unknown value. This transformer is usually one of the low-priced universal replacement units of about 3-to-1 ratio and the condenser varies in value depending on the set-up used. It frequently has a value of about .25-mf., but may vary from this value to as high as 0.5-mf. or down to 0.1-mf.

In addition, a condenser is placed across the output transformer to resonate it to these low frequencies. This, too, depends on the speaker. The correct value for maximum performance is found by experimentation. It usually runs from 0.5- to 1mf.

LIST OF PARTS

- One 3-gang tuning condenser, 350 mmf., C;
- Four Cornell-Dubilier condensers, 0.1-mf., C1;
- Eight Aerovox condensers, type GM, 8 mf., 525 V., C2;
- One Aerovox mica condenser, type 1467, 370 mmf., with Hammarlund EC-35, C3;
- One Aerovox mica condenser, type 1467, .001-mf., C4, C8;
- Two Aerovox mica condensers, type 1467, 100 mmf., C6;
- One Aerovox mica condenser, type 1467, 250 mmf., C6;
- One Aerovox mica condenser, type 1467, 500 mmf., C7;
- One Aerovox condenser, type P-5, 8 mf., 525 V., C9;
- Two Cornell-Dubilier condensers, 0.5-mf., C10;
- One Cornell-Dubilier condenser, .25-mf., C11;
- Two Cornell-Dubilier condensers (see text), C12, C13;
- Two Centralab carbon resistors, 500 ohms, 1 W., R1, R5;
- One Centralab carbon resistor, 400 ohms, 1 W., R2;
- One Centralab carbon resistor, 25,000 ohms, 1 W., R3;
- One Centralab carbon resistor, 30,000 ohms, 1 W., R4;
- Two Centralab carbon resistors, 1 meg., 1 W., R6;
- One Centralab carbon resistor, 50,000 ohms, 1 W., R7;
- One Centralab potentiometer, 1/2-meg., R8;
- One Electrad voltage-divider, 15,000 ohms, R9;
- Two Electrad resistors, 25,000 ohms, 10 W., R10, R11;
- *Two A.F. chokes, type T-3736, Ch.1, Ch.2;
- *Three filter chokes, type T-1607, Ch.3, Ch.4, Ch.5;
- *One A.F. transformer, type T-2999, Ch. 6;
- *One power transformer, type T-7021 supplying 700 V. C.T., 6.3 V., 5 V., 2 1/2 V., P.T.1;
- *Two power transformers, type T-4900 supplying 700 V., C.T., 2 1/2 V., 5 V., P.T.2, P.T.3;
- One Wright-DeCoster speaker, model 790, 2,500-ohm field, single 2A5, reproducer No. 1;
- One Wright-DeCoster speaker, model 1,980, 2,500-ohm field, single 2A5, reproducer No. 2;
- Sockets, speaker plugs, chassis, etc.
- Two Sylvania type 78 tubes, V1, V3;
- One Sylvania type 6A7 tube, V2;
- One Sylvania type 85 tube, V4;
- One Sylvania type 56 tube, V5;
- Two Sylvania type 2A5 tubes, V6, V7;
- Three Sylvania type 80 tubes, V8, V9, V10.
- *Name of manufacturer will be sent upon receipt of stamped and self-addressed envelope.

Index to Advertisers

A	
Alloy Transformer Co., Inc.....	628
Aerovox Corporation.....	629
Arex Radio.....	628
Allied Radio Corporation.....	615
American Technical Society.....	638
Ampeite Corporation.....	627, 632
American Microphone Co.....	632
Arrow Sales Corporation.....	625
B	
Capitol Radio Engineering Instit.....	623
Central Radio Laboratories.....	635
Classified Section.....	625
Cough-Brungle Co.....	621
Continental Carbon Inc.....	624
Cornell-Dubilier Corp.....	627
Commercialite Laboratories.....	635
Cayne Electrical School.....	627
D	
Dodge's Institute.....	628
E	
Electrad, Inc.....	626
Electric Institute.....	580A
Empire Radio Corp.....	625
G	
General Cement Mfg. Co.....	619
General Electric Company.....	Back Cover
General Transformer Co.....	615
Goldstone Radio Co.....	629
Greenup Company.....	631
H	
Hammarlund Mfg. Company.....	623
Hygrade-Sylvania Corp.....	625
J	
J-M-P Manufacturing Co.....	622
Jobs & Careers.....	626
L	
Lincoln Engineering School.....	618
Dr. L. Loewenberg.....	624
Arthur H. Lysch, Inc.....	625
M	
McGraw-Hill Book Co.....	618
Midwest Radio Corp.....	Inside Back Cover
Millon Radio & Television Labs.....	618
N	
National Radio Institute.....	629
National Union Radio Corp.....	622
New York YMCA Schools.....	629
O	
Oxford-Tartack Radio Co.....	623
P	
Precision Apparatus Corp.....	623
R	
Radio & Technical Publ. Co.....	614, 633
Radio & Television Institute.....	616
Radio Circular Company.....	623
Radio City Products Co.....	627
Radio Constructors Labs.....	627
Radio Publications.....	630
Radio Trading Company.....	629
Radio Training Assoc. of America Inc.....	628
Radolek Company.....	629
Radio Production Corp.....	629
RCA Institutes, Inc.....	632
ROA Manufacturing Co., Inc.....	626
Readrite Meter Works.....	621
Readington Rand, Inc.....	632
S	
S. O. S. Corporation.....	625
Sears, Roebuck & Co.....	627
Shallcross Mfg. Company.....	622
Short Wave Listener.....	629
Solar Mfg. Company.....	622
Sprague Products Co.....	619
F. L. Spaytherry.....	624
Standard Transformer Corp.....	619
Supreme Instruments Corp.....	Inside Front Cover
T	
Teletex Company.....	615
Thor Radio Company.....	629
The Trailer Plan Shop.....	613
Triplet Electrical Instrument Co.....	627
Triumph Manufacturing Co.....	627
U	
United Transformer Corp.....	633
V	
D. I. Van Leuven.....	628
Victory Mfg. & Dist. Co.....	635
W	
Wellworth Trading Co.....	628, 634
Weston Electrical Instr. Corp.....	617
Wholesale Radio Service Co., Inc.....	624
Wright-DeCoster, Inc.....	628
Z	
Zephyr Radio Company.....	619

(While every precaution is taken to insure accuracy, we cannot guarantee against the possibility of an occasional change or omission in the preparation of this index.)

Again... MIDWEST RADIO

Proves Its Leadership!

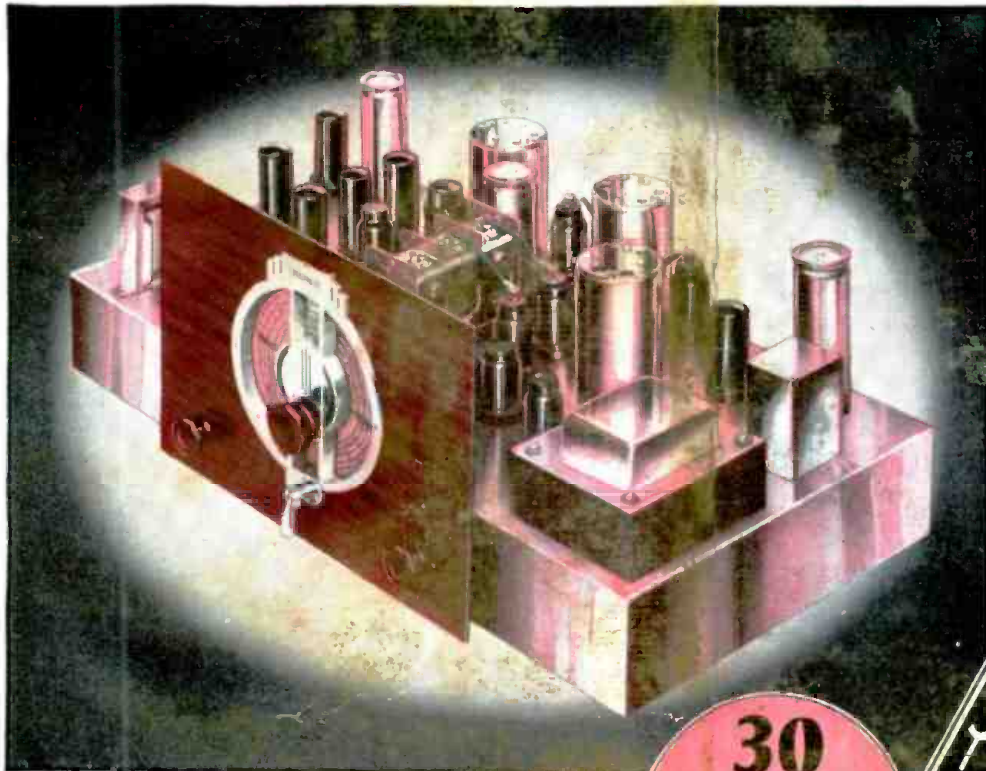

with a
MARVELOUS NEW

14-Tube

**FIVE WAVE BAND,
WORLD WIDE SET**

**9 TO 2400
METERS**

**30
DAYS
FREE
TRIAL**

\$39.50
with New
**AUDITORIUM TYPE
SPEAKER**
(LESS TUBES)

**EASY
PAYMENT
TERMS**

**DEAL DIRECT WITH LABORATORIES
SAVE UP TO 50%**

ONCE again, Midwest demonstrates its leadership by offering the world's most powerful Super DeLuxe 14-METAL Tube 5-band radio. It is a master achievement... today's most highly perfected, precisely built, laboratory adjusted set. It is a radio-musical instrument that will thrill you with its marvelous super performance... glorious new acousti-tone... crystal-clear "concert" realism... and magnificent foreign reception. Before you buy any radio, write for FREE 40-page 1936 catalog. Learn about the successful Midwest Laboratory-To-You policy that saves you 30% to 50%... that gives you 30 days FREE trial. This super radio will out-perform \$100 and \$200 sets on a side by side test. It is so powerful, so amazingly selective, so delicately sensitive that it brings in distant foreign stations with full loud speaker volume, on channels adjacent to powerful locals. The 14 tubes permit of advanced circuits, make it possible to use the tremendous reserve power, and to exert the sustained maximum output of the powerful new tubes.

50 SENSATIONAL ADVANCEMENTS

Scores of marvelous Midwest features, many of them exclusive, explain Midwest glorious tone realism, super performance and thrilling world-wide 5-band reception. They prove why nationally known orchestra leaders like Fred Waring, George Olsen, Jack Denny, etc., use a Midwest in preference to more costly makes. Five tuning ranges make it easy to parade the nations of the world before you. You can switch instantly from American programs... to Canadian, police, amateur, commercial, airplane and ship broadcasts... to the finest and most fascinating programs from Europe, Africa, Asia, Australia South America... 12,000 miles away.

Acousti-Tone V-Spread Design (U. S. Design Patent No. 96750)

The V-Front Dispersing Vanes established a new radio style overnight. They spread the beautiful lace-work of the "highs" throughout the room in a scientific manner... directing the High Fidelity waves uniformly to the ear. Now, get complete range of audible frequencies... achieving glorious new acousti-tone... assuring life-like crystal-clear "concert" realism. No middlemen's profits to pay. You buy at wholesale prices, direct from Laboratories... saving 30% to 50%. You can order your 1936 Midwest radio from the new 40-page catalog with as much certainty of satisfaction as if you were to come yourself to our great laboratories. You save 30% to 50%... you get 30 days' FREE trial... as little as \$5.00 down puts a Midwest radio in your home. Your are triply protected with a One-Year Guarantee, Foreign Reception Guarantee, Money-back Guarantee.

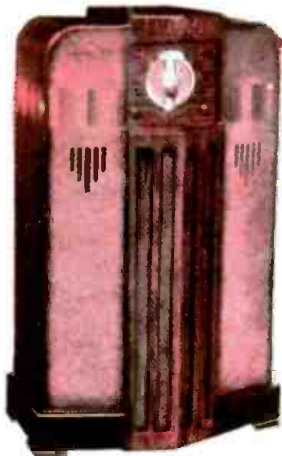

Ted Weems Enthusies Over Foreign Reception

"After comparing many radios, I can truthfully say that my Midwest out-performs other sets costing almost twice as much. In all my experience, I have never heard such life-like reproduction. My Midwest surpasses all my expectations, and in my opinion, is the finest radio receiver obtainable."
TED WEEMS.

Send for FREE 40-page four-color catalog. It pictures the complete line of beautiful 1936 Midwest Acousti-Tone V-Spread consoles and chassis... in their natural colors.



MAIL COUPON TODAY for

**Free 30-DAY TRIAL OFFER
and 40-PAGE FOUR-COLOR Free CATALOG**

**MIDWEST RADIO CORPORATION
Dept. 12L, Cincinnati, Ohio**

Without obligation on my part, send me your new FREE catalog and complete details of your liberal 30-day FREE trial offer. This is NOT an order.

User-Agents
Make Easy
Extra Money
Check
Here
for details.

Name _____
Address _____
Town _____ State _____
 Check if interested in a Midwest All-Wave Battery Radio

MIDWEST RADIO CORP.

DEPT. 12L CINCINNATI, OHIO U.S.A.

Established 1920 Cable Address MIRACO All Codes

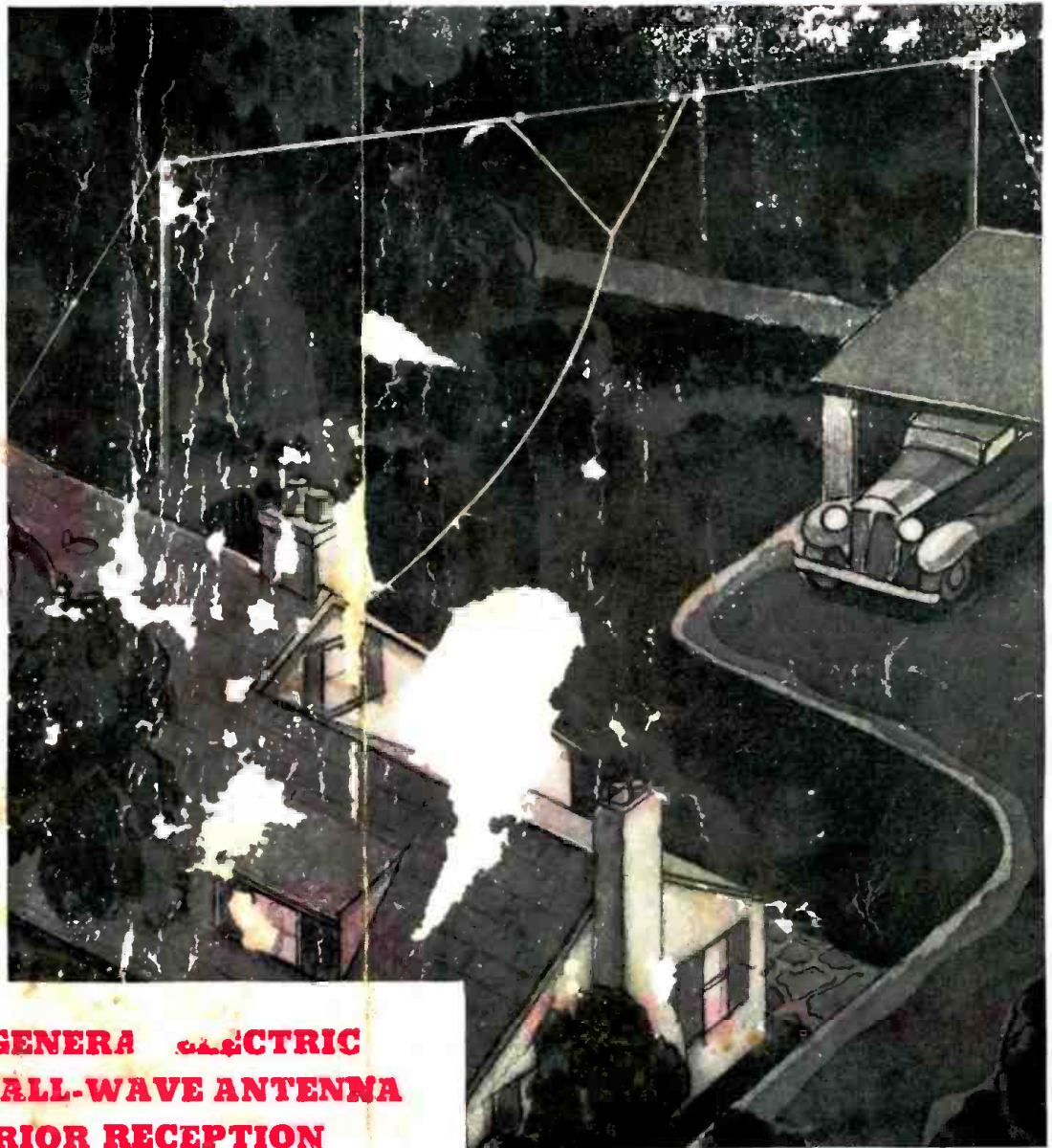

**INSTALL A GENERAL ELECTRIC
"V-DOUBLET" ALL-WAVE ANTENNA
FOR SUPERIOR RECEPTION**

DIRECTIONAL CHARACTERISTICS

The "V-doublet" Antenna System is ideally suited to take full advantage of directional effects. When the antenna system is placed at right angles to the direction of the incoming signal, the signal will come through at maximum energy. When the antenna span points towards a known source of local interference, it decreases the pick-up of noise from that source.

**EXCELLENT SENSITIVITY ON ALL
SHORT-WAVE FREQUENCIES**

The "V-doublet" is very broadly peaked in the short-wave band. The tapered "V" section couples the antenna to the transmission line in a manner that permits the transfer of signal energy over a wide frequency range, without favoring any particular short-wave frequency.

A specially constructed receiver-coupling transformer affords proper electrical matching for modern radio receivers equipped with antenna coils having a relatively large number of turns in the primary circuit.

BALANCED TRANSMISSION LINE

Short-wave signals intercepted by the "V-doublet" are fed to the receiver through a balanced, twisted-pair, transmission line. Since the transmission line serves only to transfer signals from the doublet to the receiver it minimizes "man-made" static which originates from the house wiring system and external electrical apparatus, including even ignition systems of passing automobiles.

**DOUBLET FOR SHORT-WAVE—
T TYPE FOR STANDARD BROADCAST**

In the reception of standard broadcasts, the G-E "V-doublet" Antenna System is automatically converted from its "V-doublet" form to one approximating the conventional "T" type arrangement. This change-over is accomplished automatically by the special circuit employed in the receiver-coupling transformer.

EASY TO INSTALL

The "V-doublet" All-wave Antenna Kit, consisting of the doublet wires, glass strain insulators, and transmission line is assembled and packed ready for installation. It's easy to install, requiring only two points of suspension over a 50-foot span.

PRICE - - Model KV-100 - - \$5.00

Available at your local
General Electric Radio Dealer

GENERAL  ELECTRIC

THE ORIGINAL METAL-TUBE RADIO
APPLIANCE AND MERCHANDISE DEPARTMENT
GENERAL ELECTRIC COMPANY
BRIDGEPORT CONNECTICUT